

# The Heart physiology I.

(excitation, conduction, contraction...)

Milan Chovanec



Department of Physiology  
2<sup>nd</sup> Medical School, Charles University, Prague

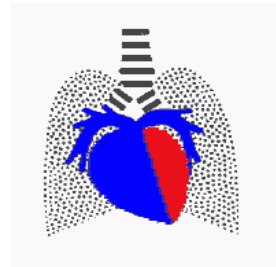

# The Heart Physiology

- The heart action potential (working myocardium)
- The heart automaticity and electrical conduction system
- Excitation – Contraction coupling in the heart muscle cells

# Myocardium = syncytium

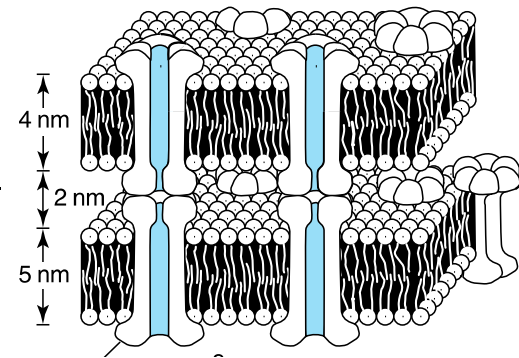
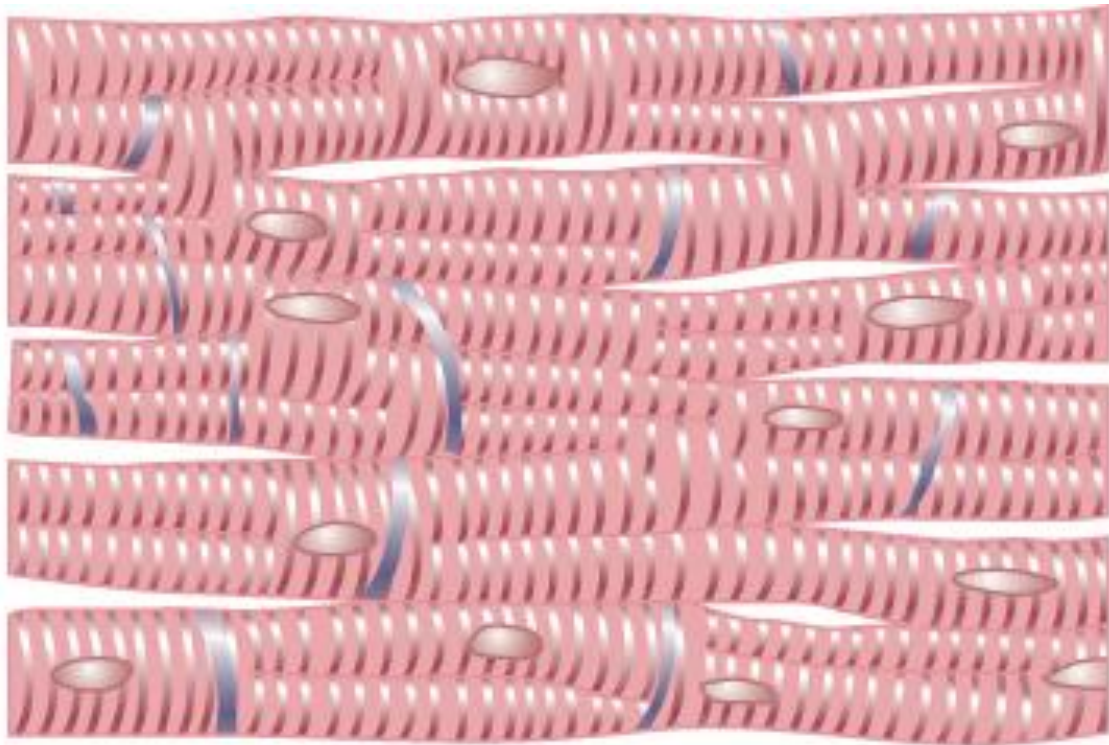

Gap junction = nexus

# Different types of the action potential in the heart

## Skeletal muscle, nerve

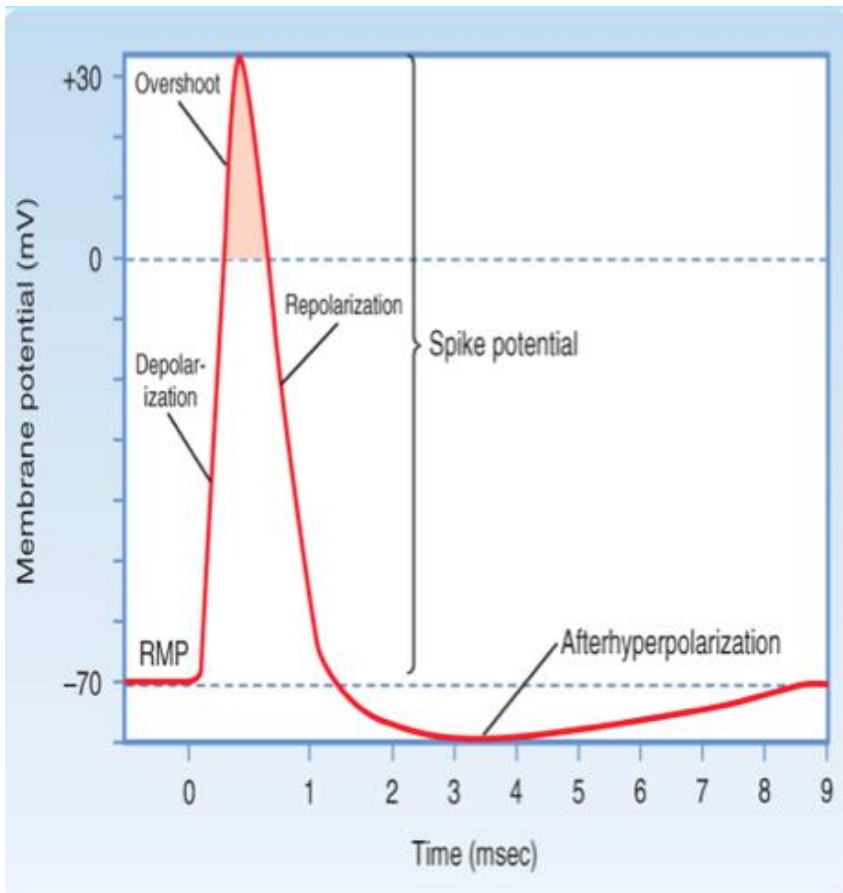

Koepfen & Stanton: Beme and Levy Physiology, 6th Edition.  
Copyright © 2008 by Mosby, an imprint of Elsevier, Inc. All rights reserved

## Myocardium

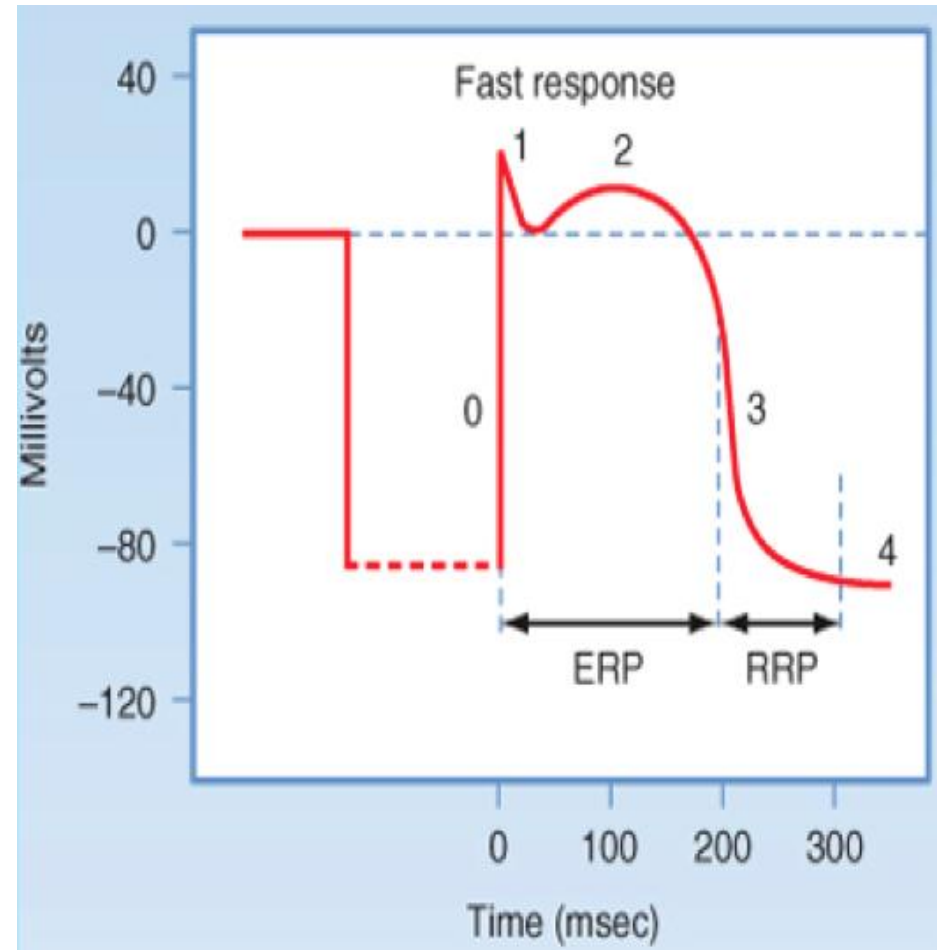

# Voltage gated $\text{Ca}^{2+}$ channels (L-type) are responsible for AP in the myocardium

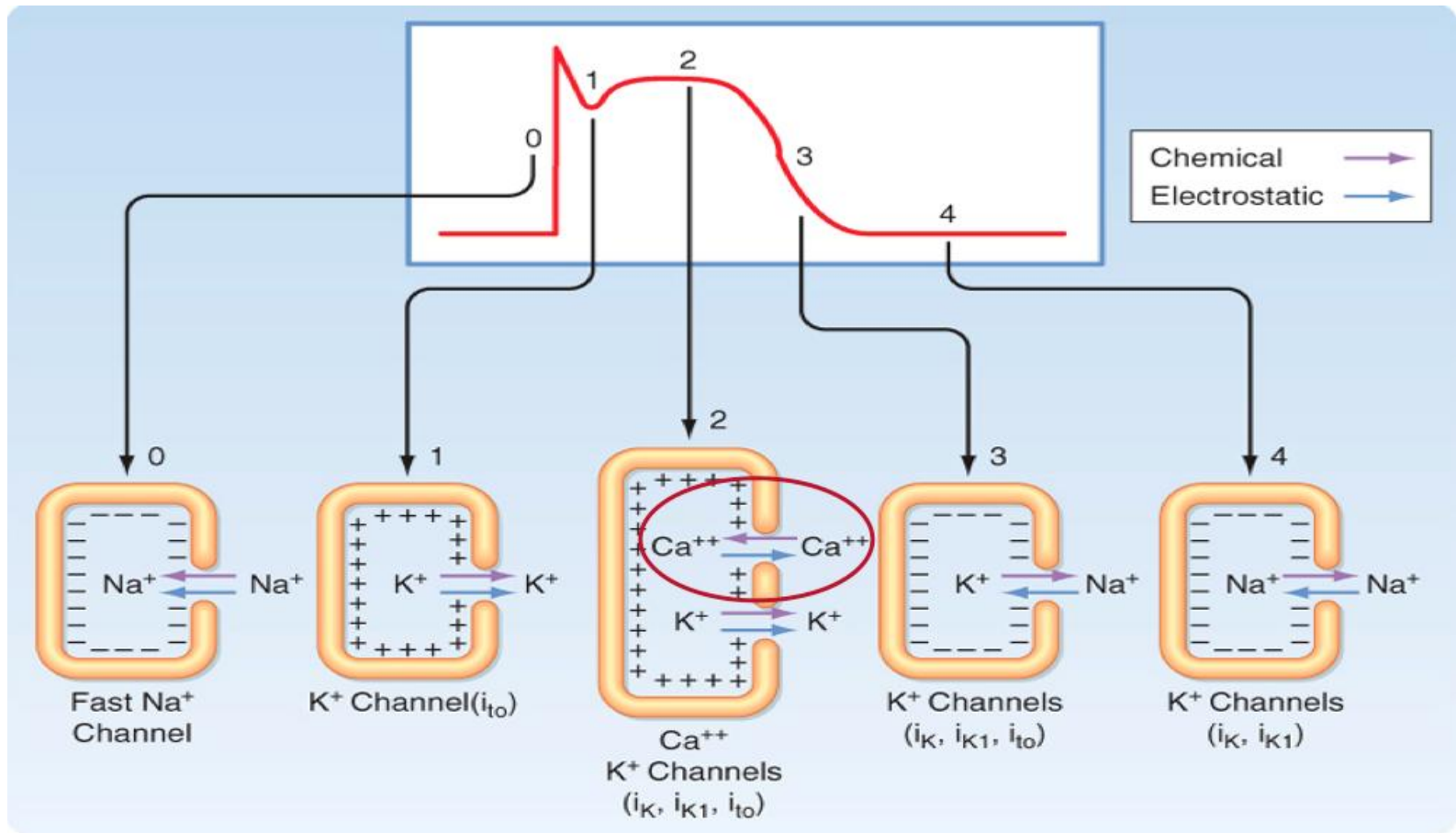

# Calcium influx plays role in strength and duration of the myocardial AP

Relationship between the strength + duration of the AP and calcium channels blocker (Verapamil)

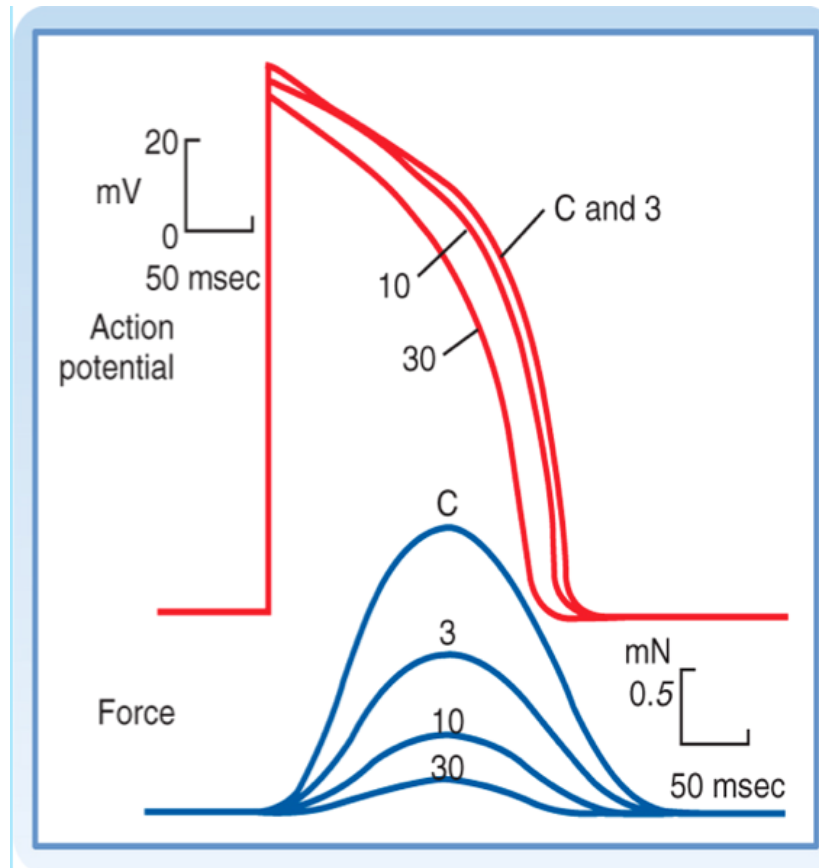

# Prolonged AP prevents tetanic myocardial contraction

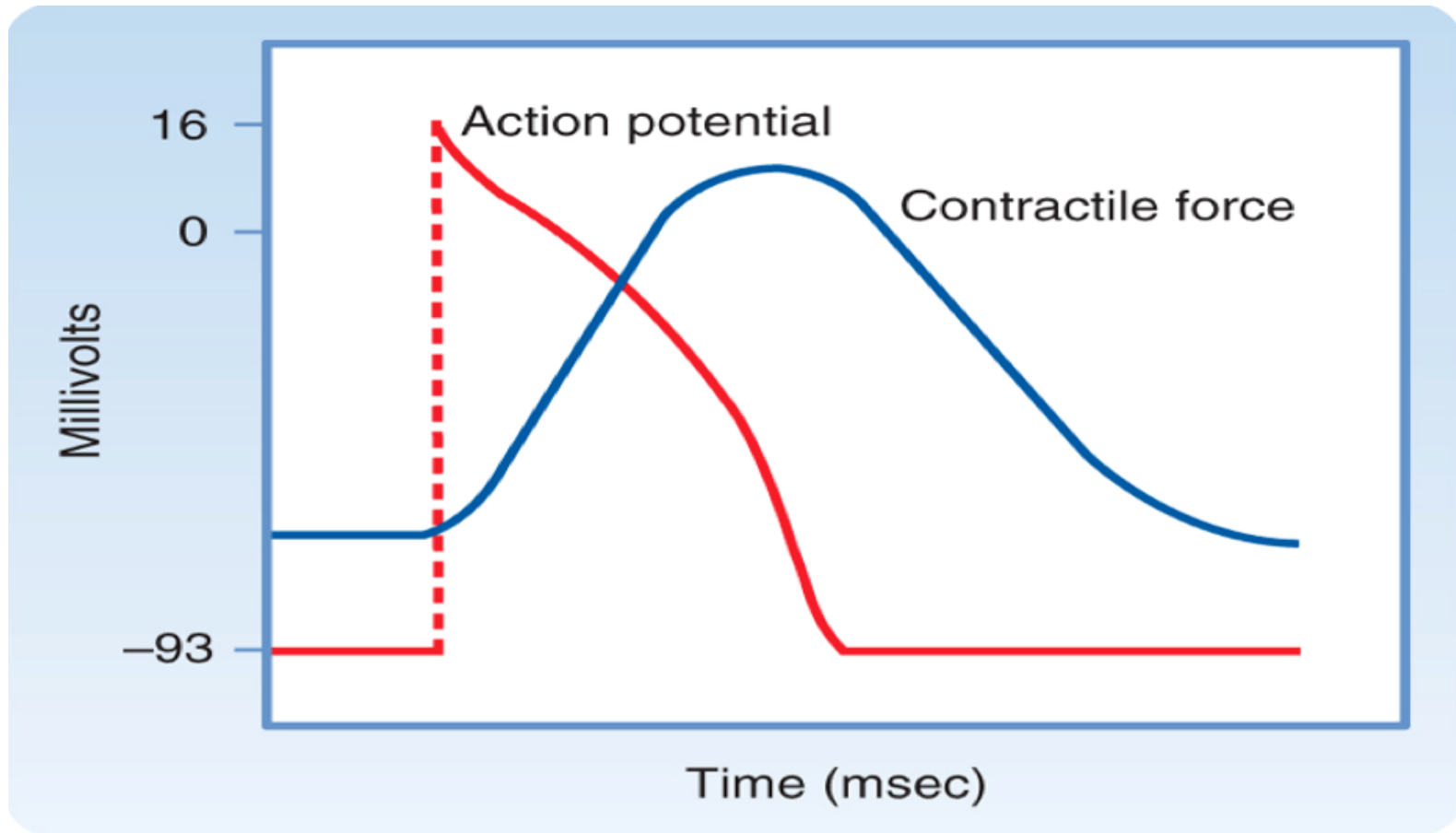

# Cardiac cells types

- working myocardium cells, about 99%
- electrical conduction system cells, about 1%

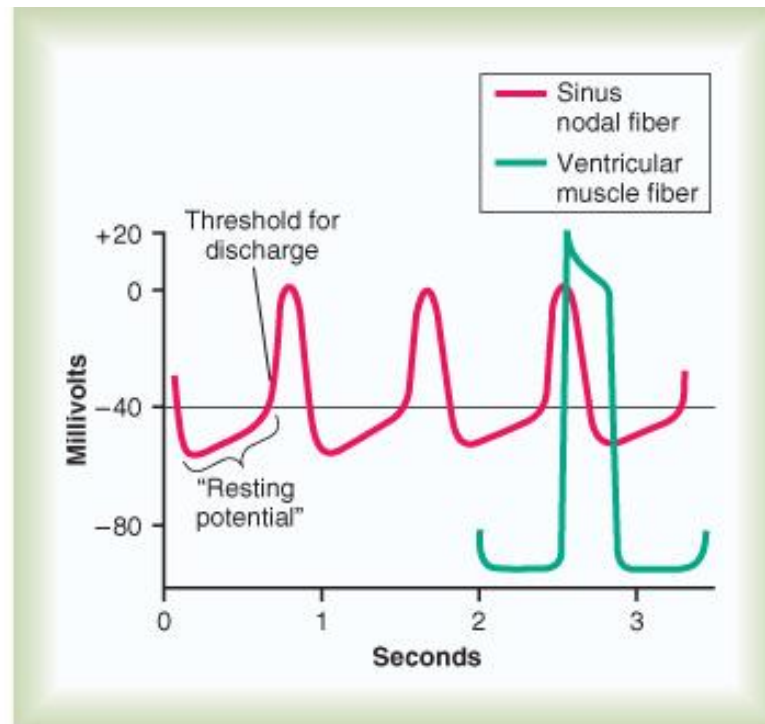



# Electrical conduction system AP

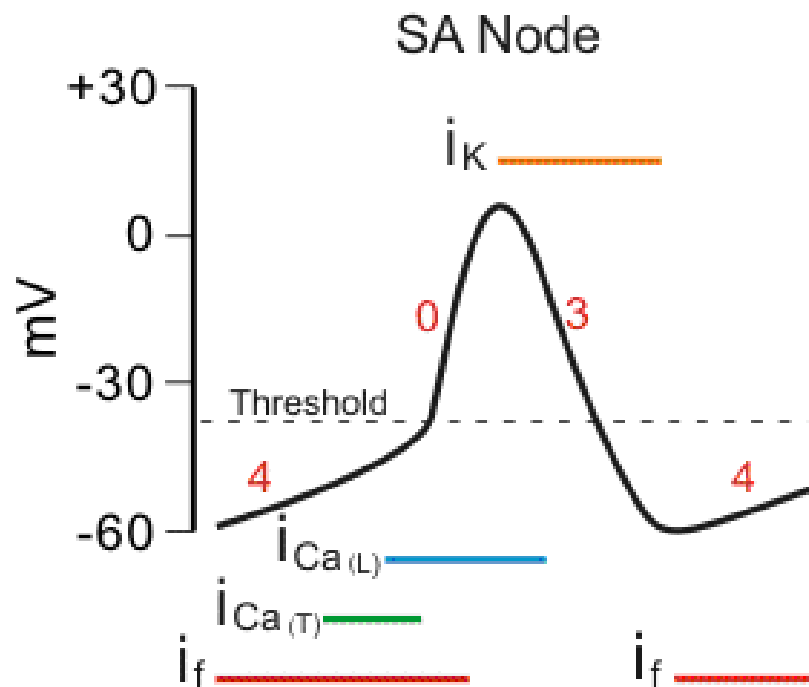

$i_f$  – „funny current“,  $Na^+$  - channels  
 $i_{Ca(T)}$  – „transient“  $Ca^{2+}$  channels  
 $i_{Ca(L)}$  – „long lasting“  $Ca^{2+}$  channels

sinoatrial (SA) pacemaker action potential

# Difference between AP of the working myocardium and the conduction system

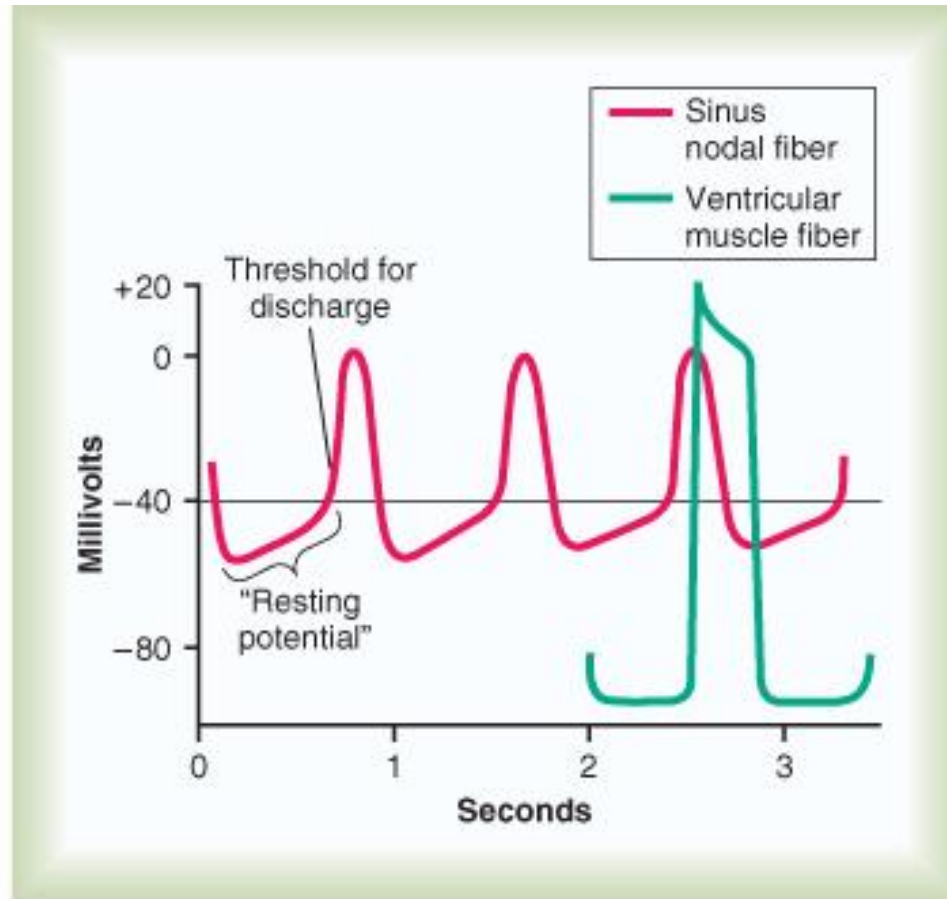

**RMP**



# Conduction of the heart

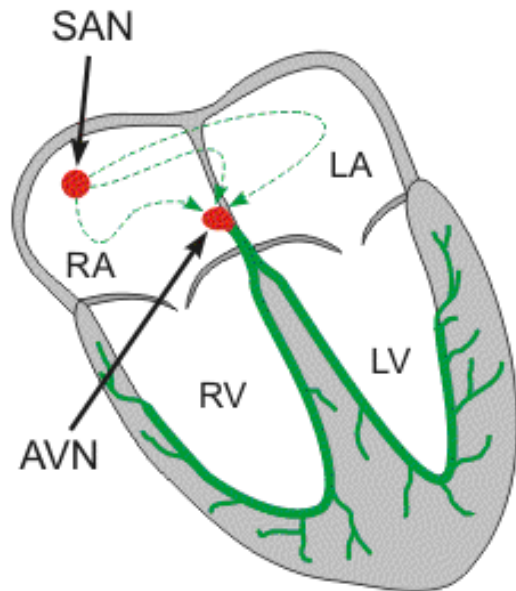

SAN, sinoatrial node; AVN, atrio-ventricular node; RA, right atrium; LA, left atrium, RV, right ventricle; LV, left ventricle.

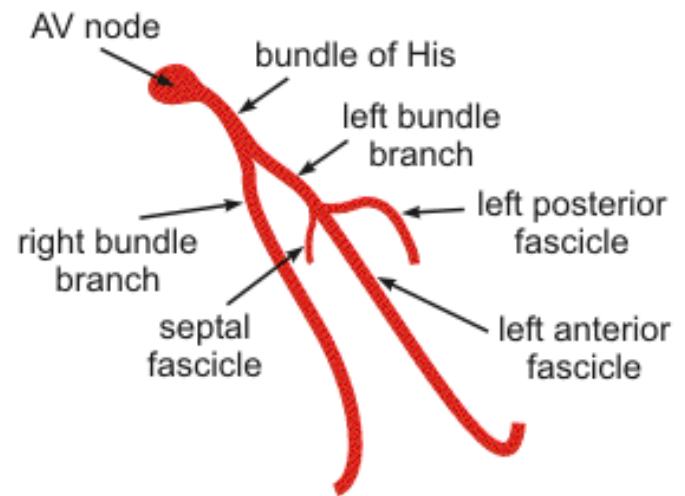

# The heart AP propagation



# Electrical characterization of the myocardium

## Constant parameters:

- velocity of the activation
- refractory period of the myocardium
- anatomical dimensions

# Excitation – Contraction coupling in the cardiac muscle

- Spontaneous the heart AP (automacity)
- Gap junctions
- T-tubules
- Contractile elements
- SR
- Mitochondria (ATP)
- $\text{Ca}^{2+}$  ions

# Structure of the myocardium

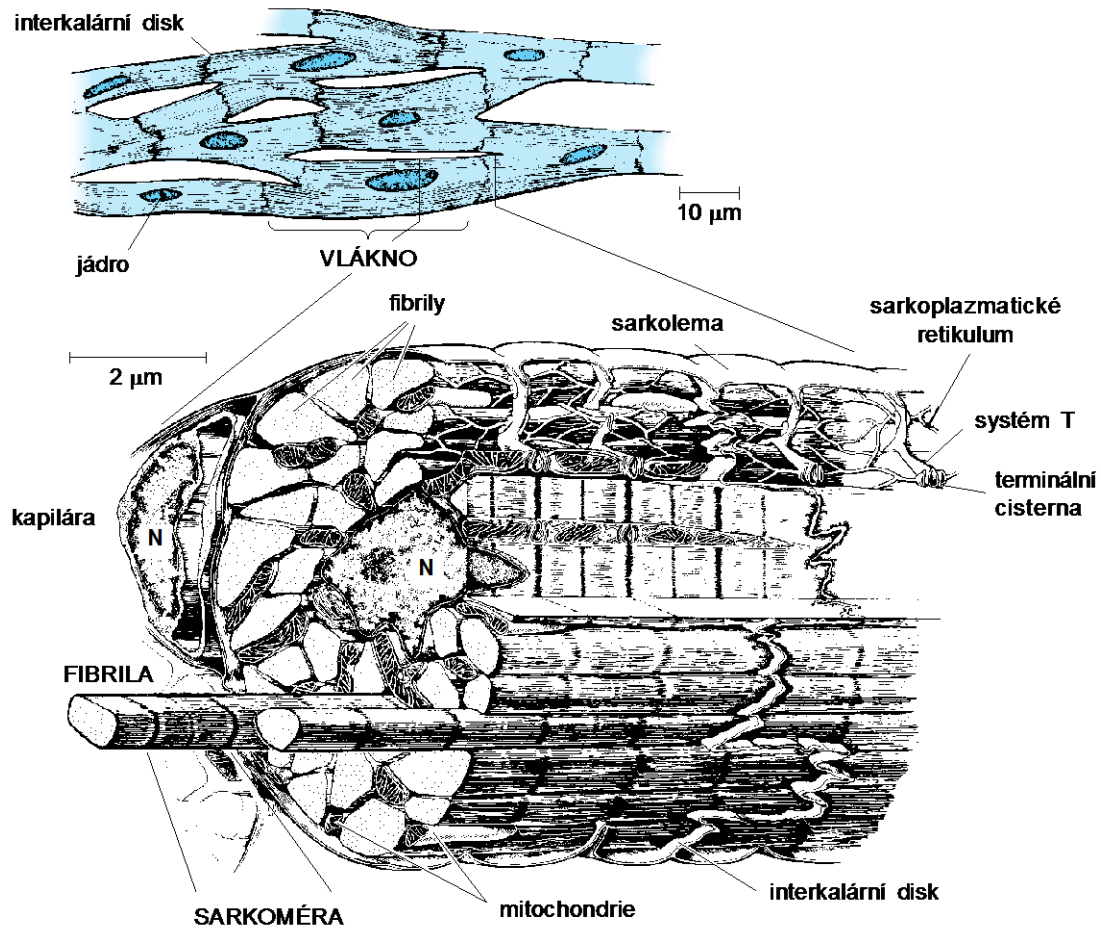



# Contractile elements

- Myosin – the heads=ATPase activity
- Actin
- Tropomyosin
- Troponin complex – TnT, TnC, TnI

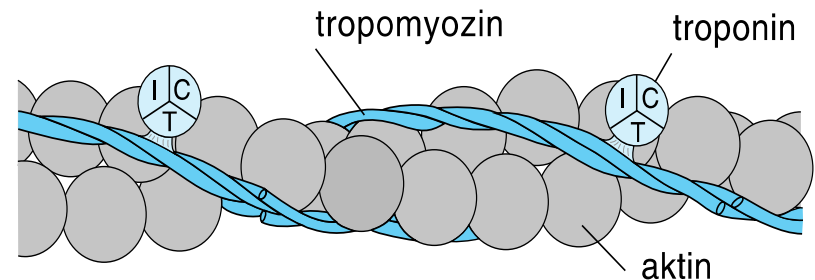
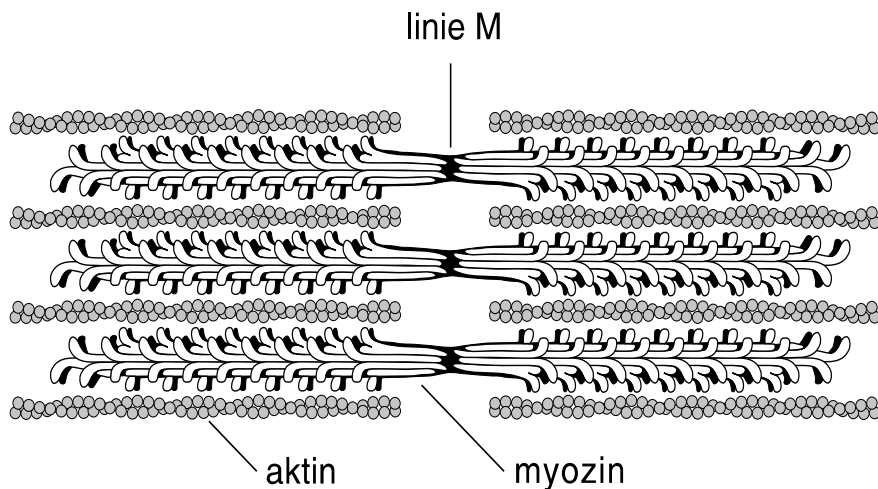

# Actin and myosin interaction

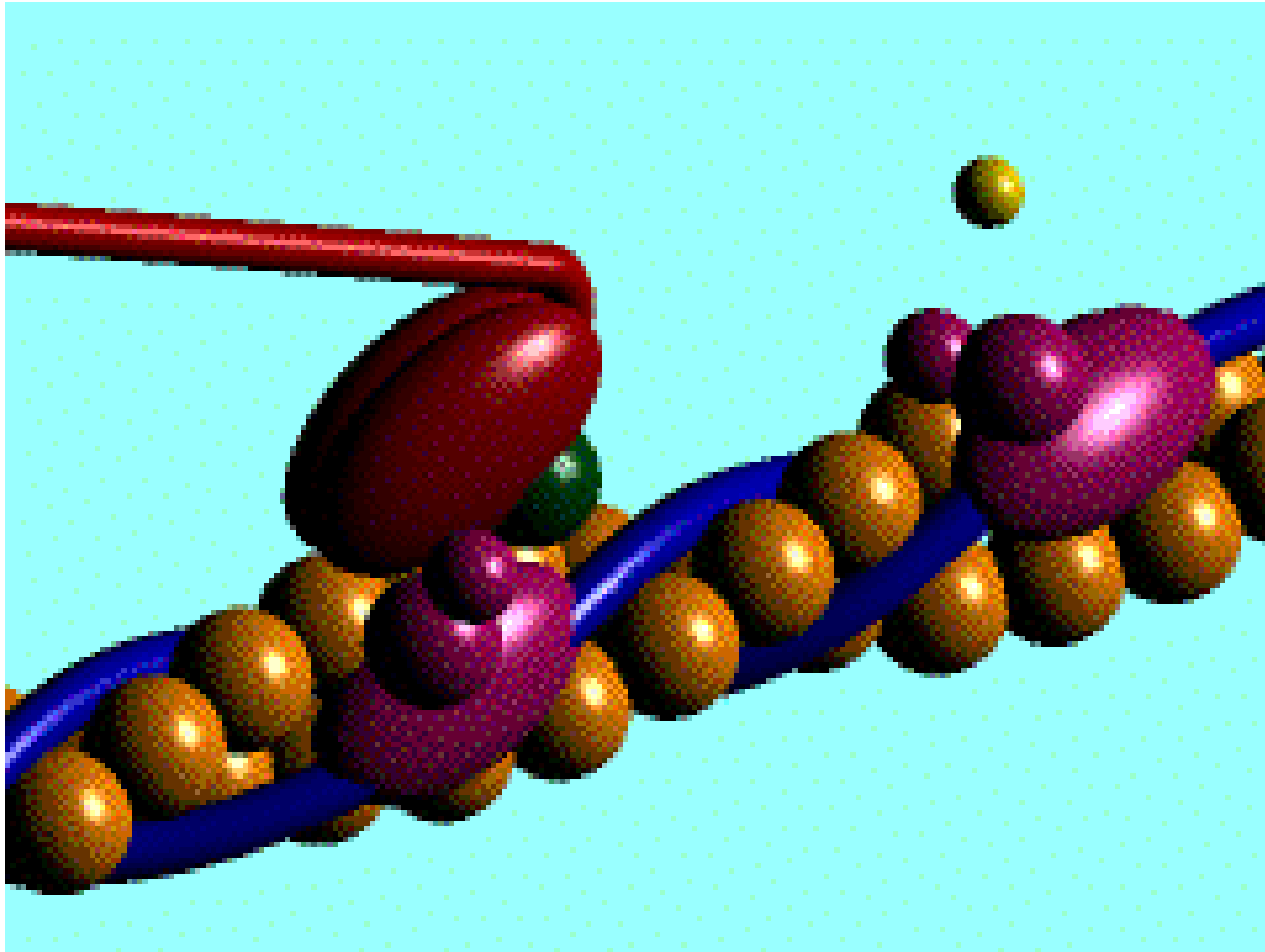

# Excitation – Contraction coupling: initiation of the contraction mechanism

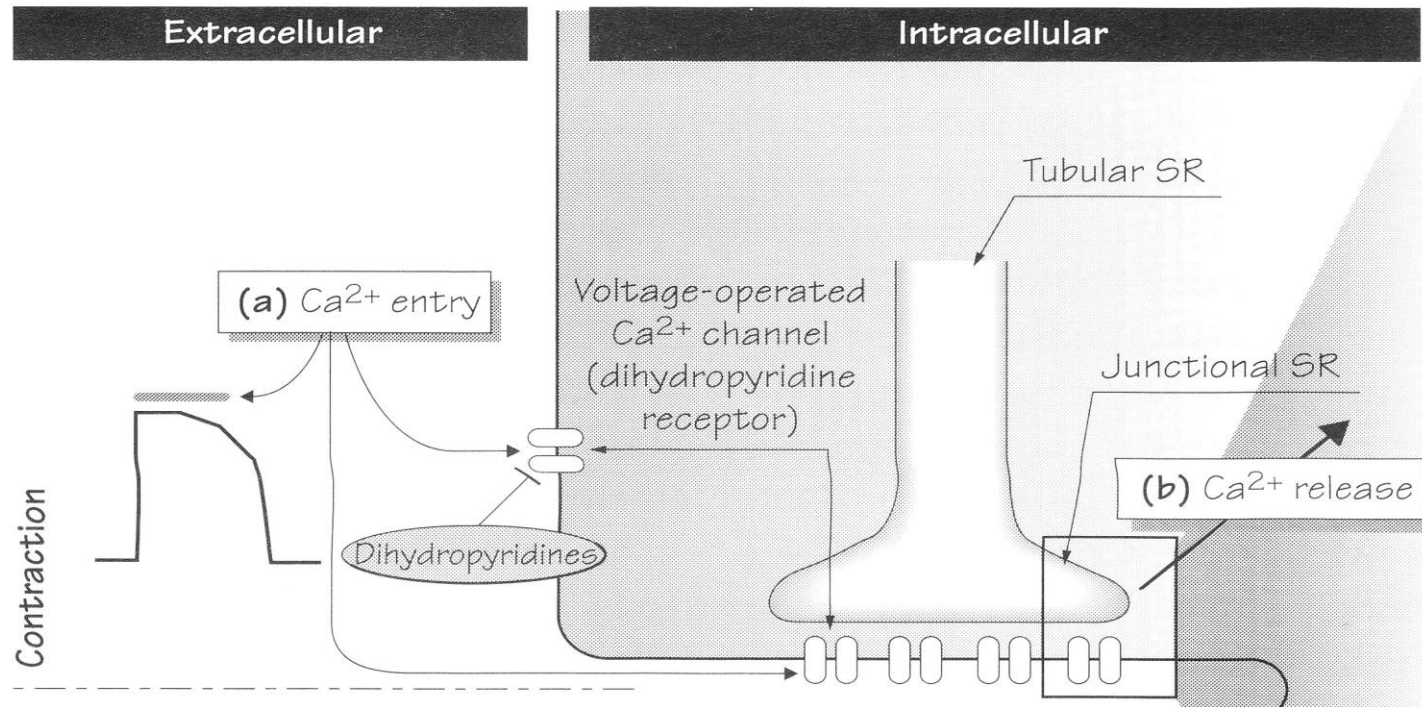

Calcium influx is essential to initiation of the myocardium contraction (about 20% of Ca<sup>2+</sup>), but this amount of calcium is not sufficient to induced whole contraction



# Excitation – Contraction coupling: relaxation mechanism

Relaxation

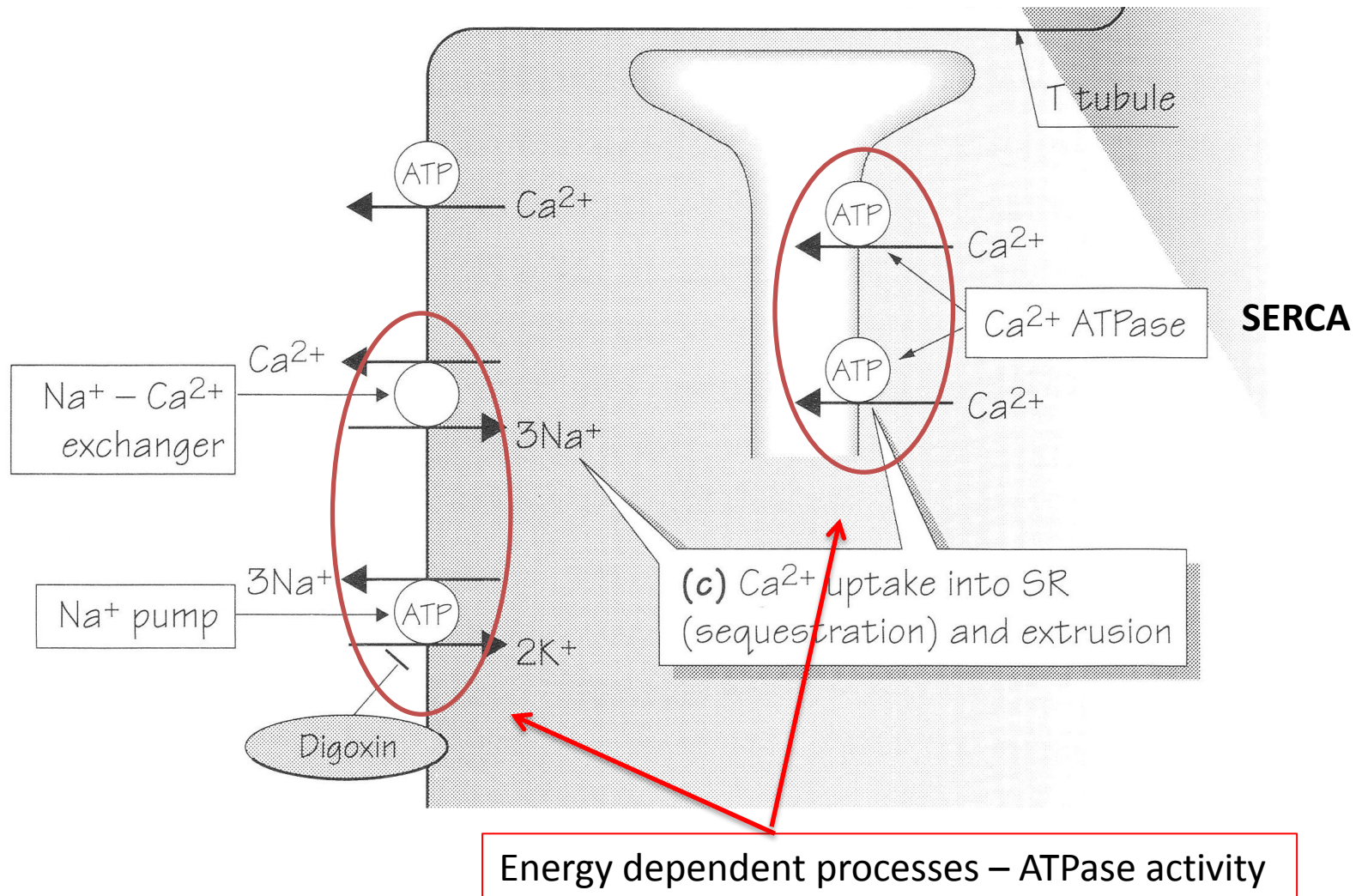

Energy dependent processes – ATPase activity

# Excitation – Contraction coupling

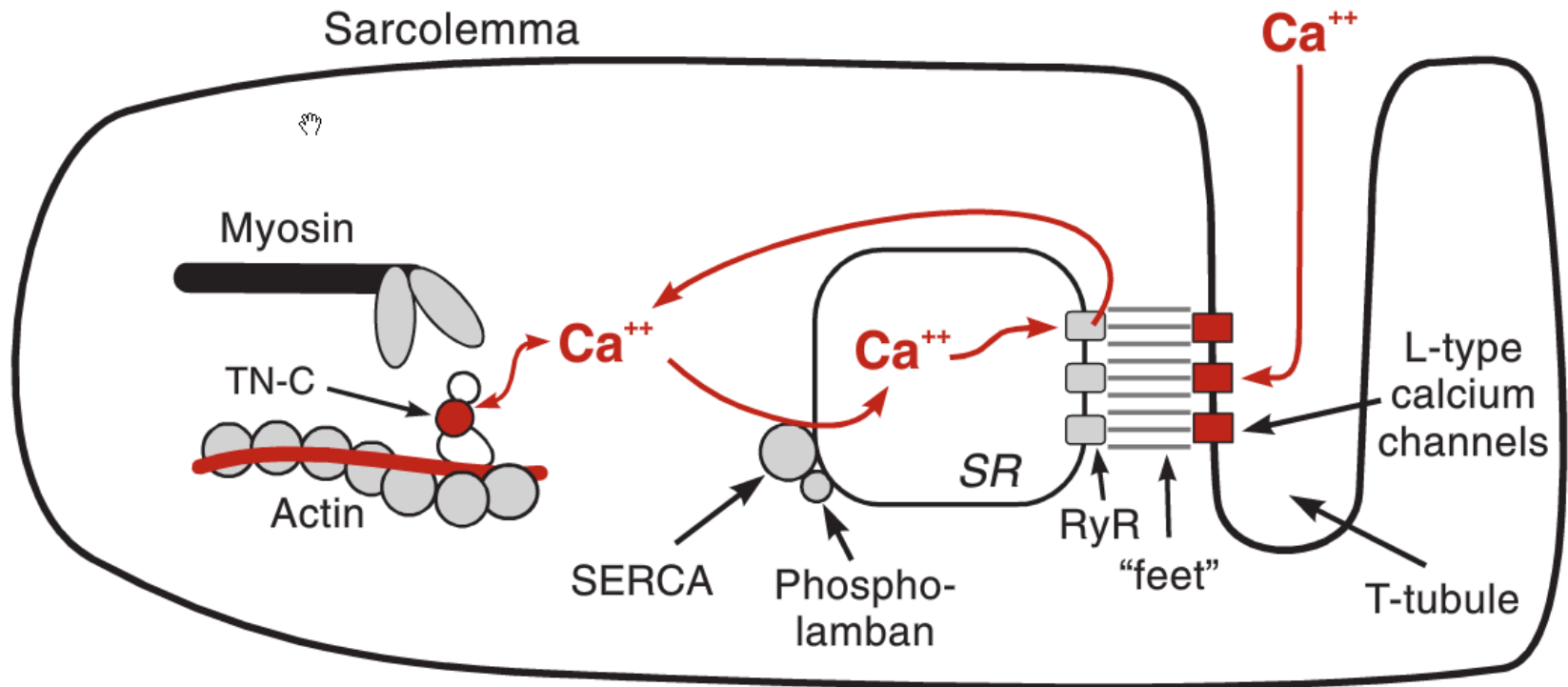

# Calcium ions during excitation – contraction coupling

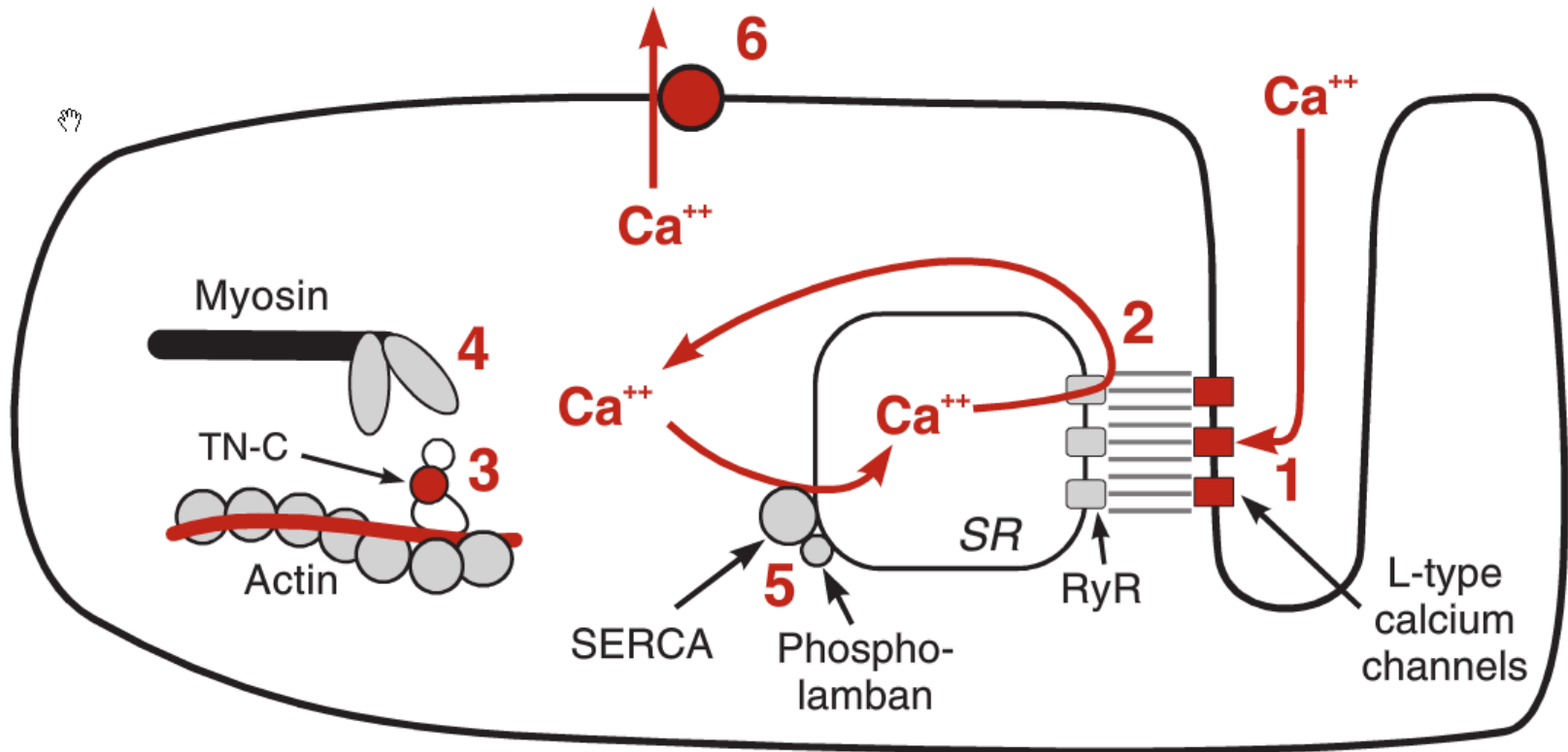

# Homeometric regulation of contraction by catecholamins

Fosforylation of fosfolambam  
faster relaxation

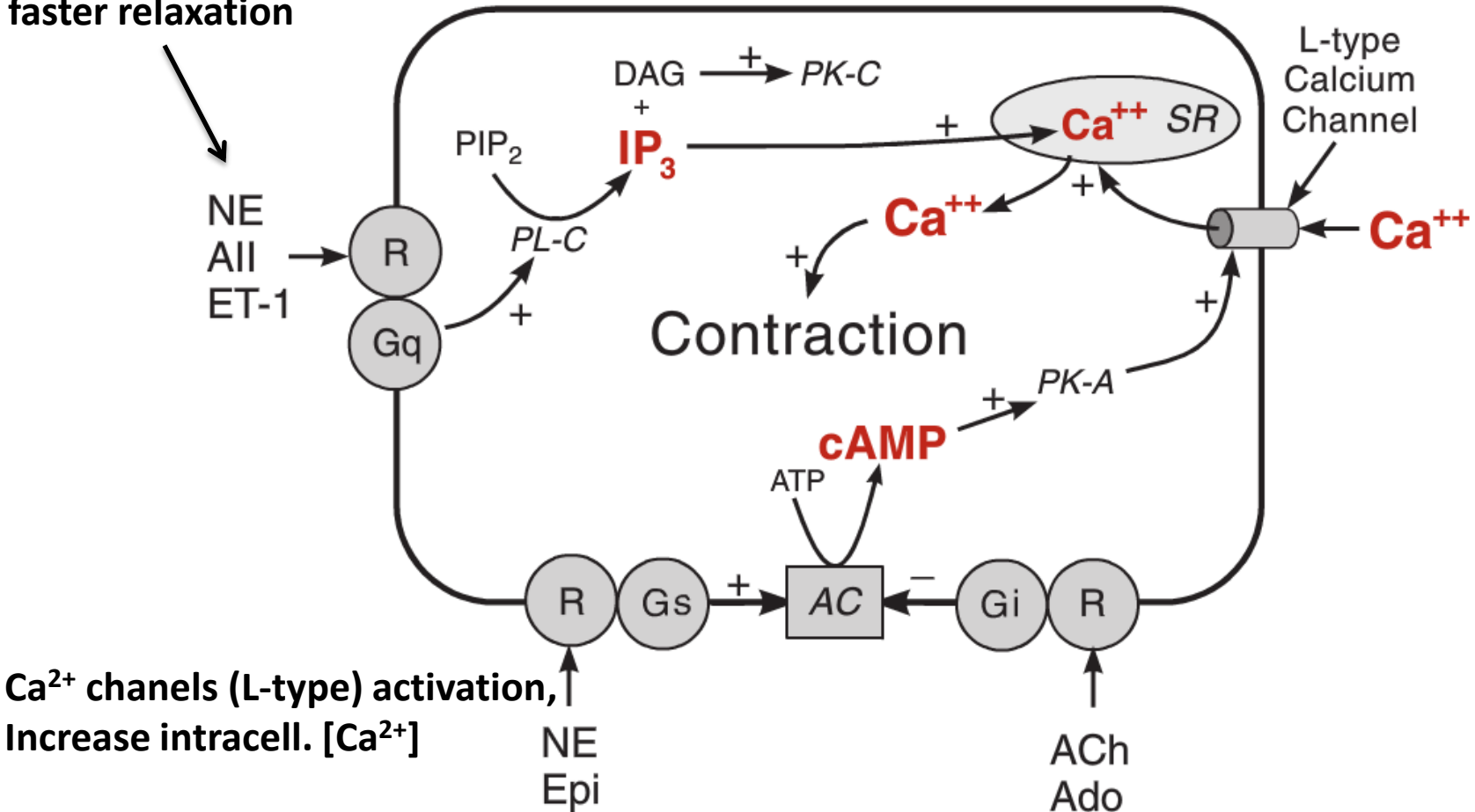



Thank you

# Spřažení kontrakce - relaxace

