

# Ionization

The Townsend (symbol Td) is a physical unit of the reduced electric field (ratio  $E/N$ ), where  $E$  is electric field and  $N$  is concentration of neutral particles. It is named after John Sealy Townsend, who conducted early research into gas ionization.

# Energy levels He

## Grotrian diagram He

## Ionization energy He

24.46eV

24.46eV  $\rightarrow$   $\sim 198400 \text{ cm}^{-1}$   $\rightarrow$   $\sim 50 \text{ nm}$   
vacuum ultraviolet



Рис. 3.8. Схема уровней атома He

## Ionization cross section

# Ionization by electron impact

## Atoms

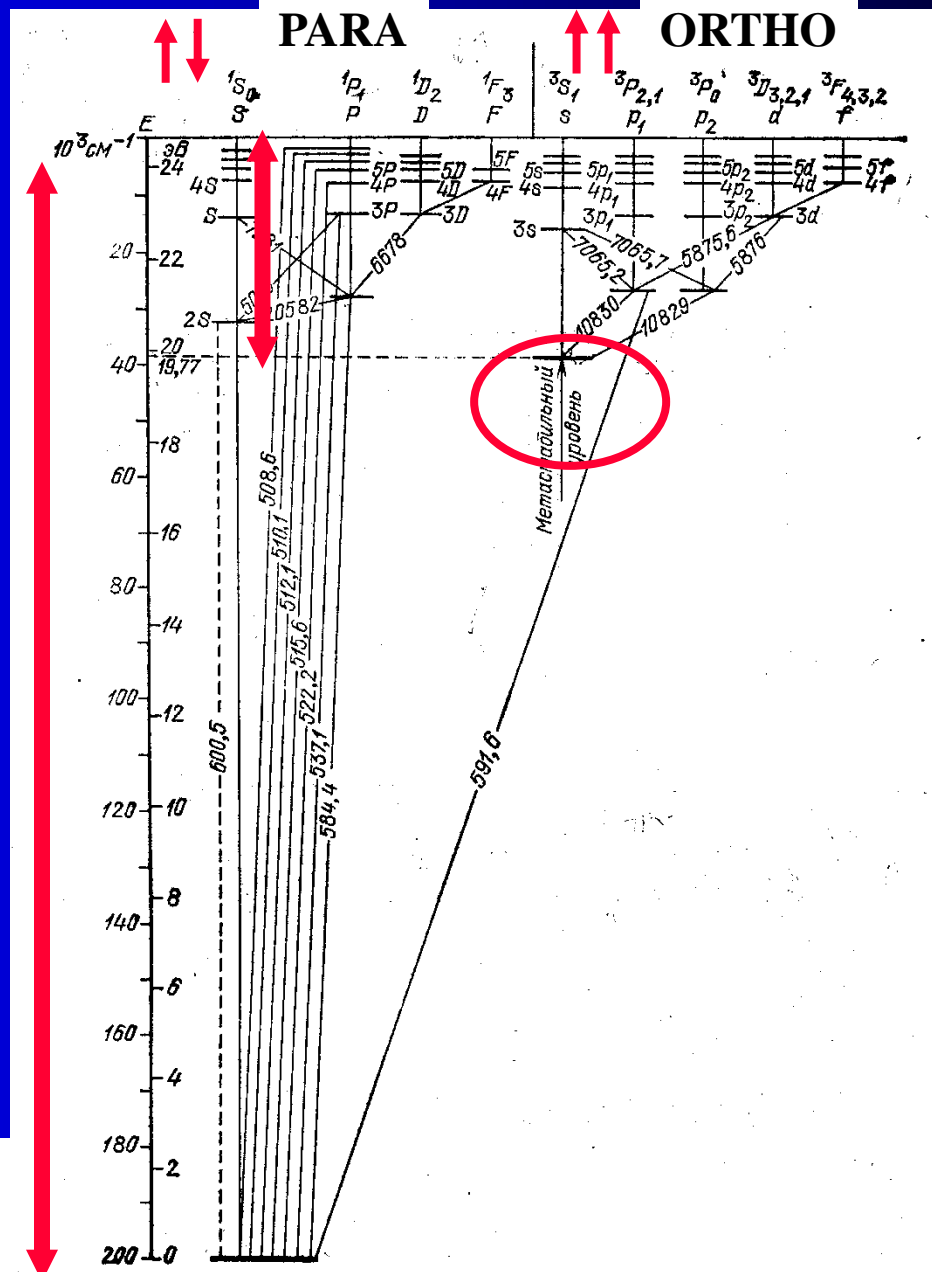

## Molecules

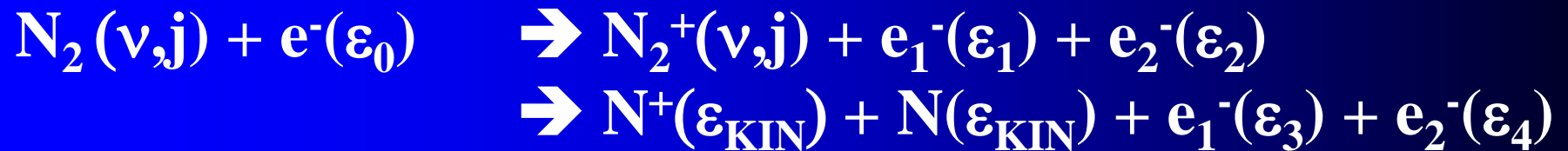

# Ionization by electron impact

## Interaction of electrons with atoms and molecules

Ionization by electron impact

Excitation by electron impact

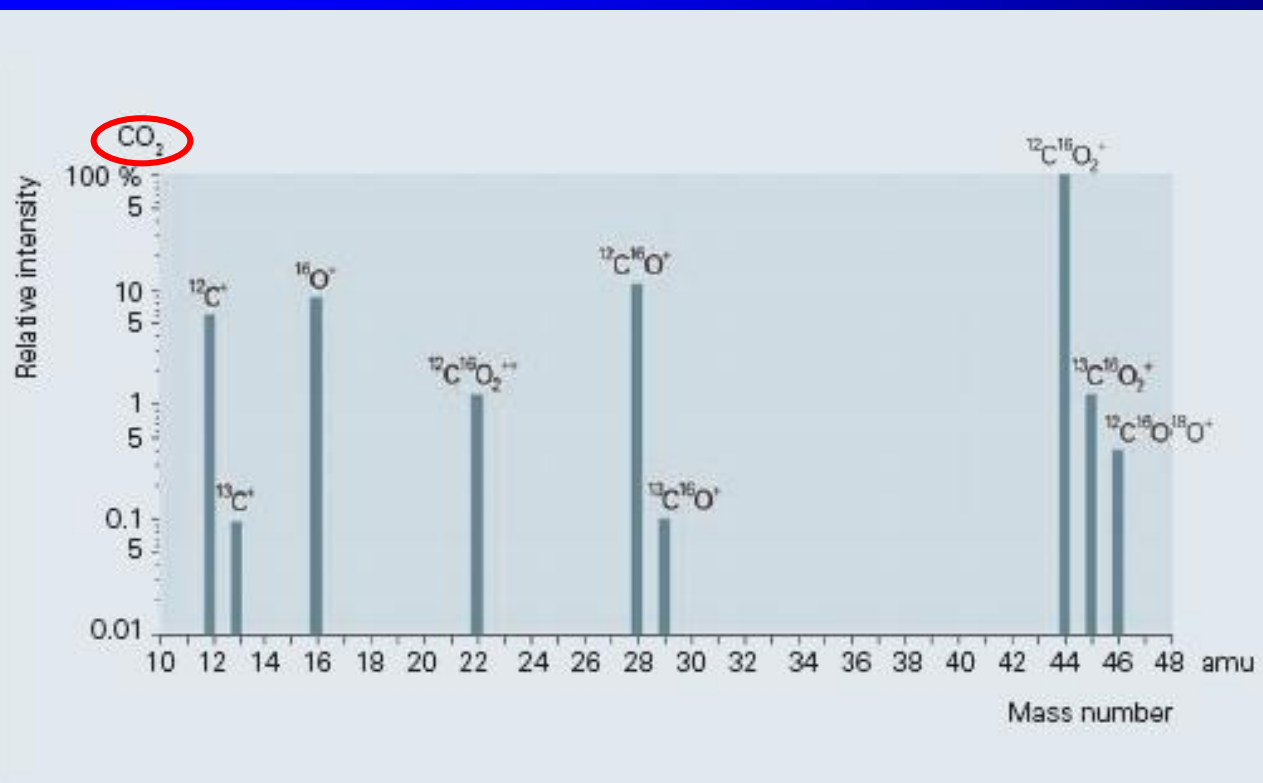

$\text{N}_2$	28.0062
$\text{CO}$	27.9949
$\text{C}_2\text{H}_4$	28.0312

# Ionization energies

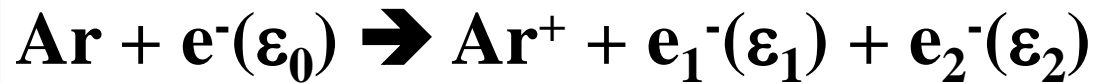
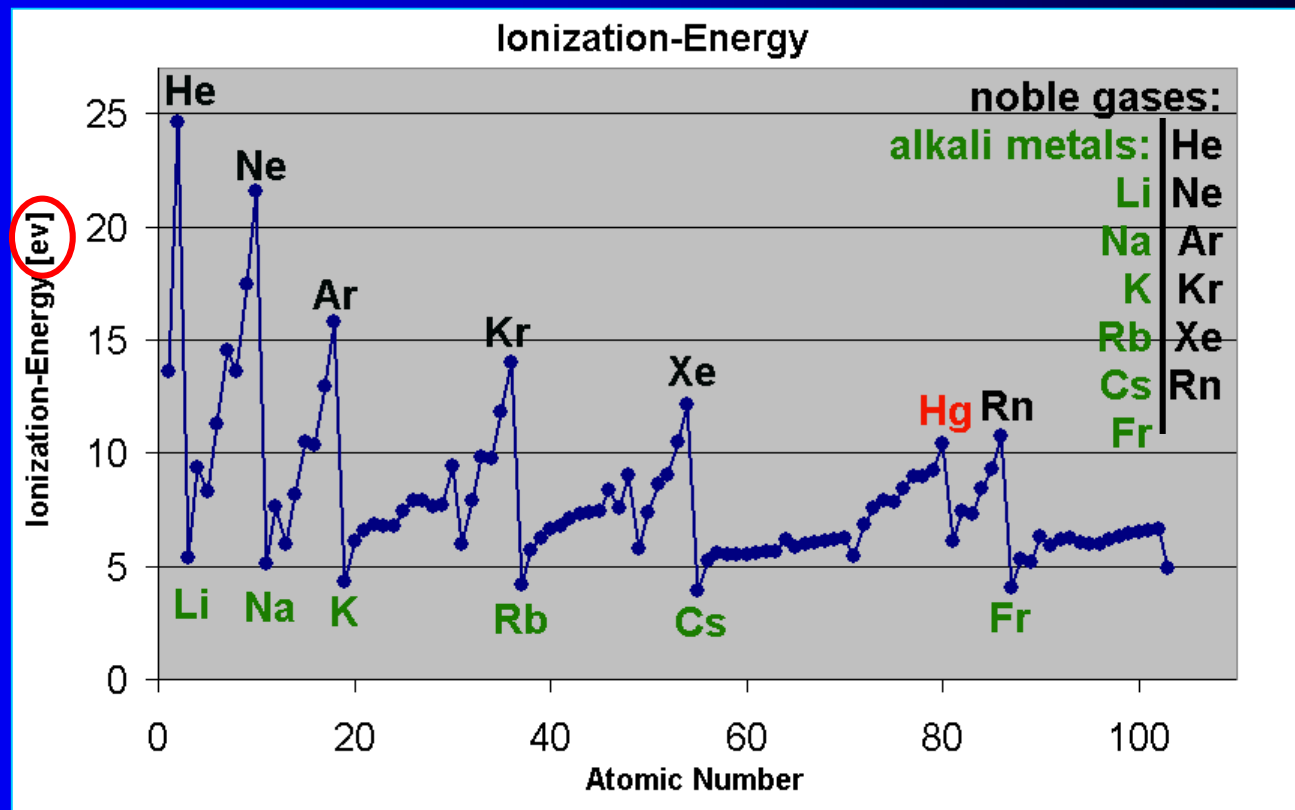

# Ionization energies

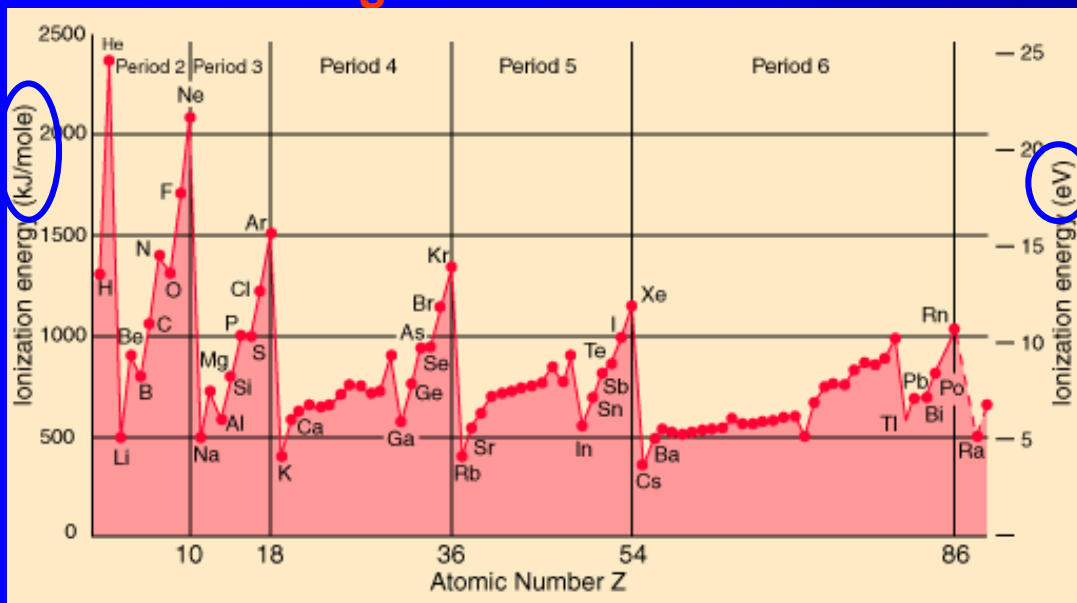

# Ionization Energy

- **First ionization energy (IE<sub>1</sub>)**

The minimum amount of energy required to remove the most loosely bound electron from an isolated gaseous atom to form a 1+ ion.

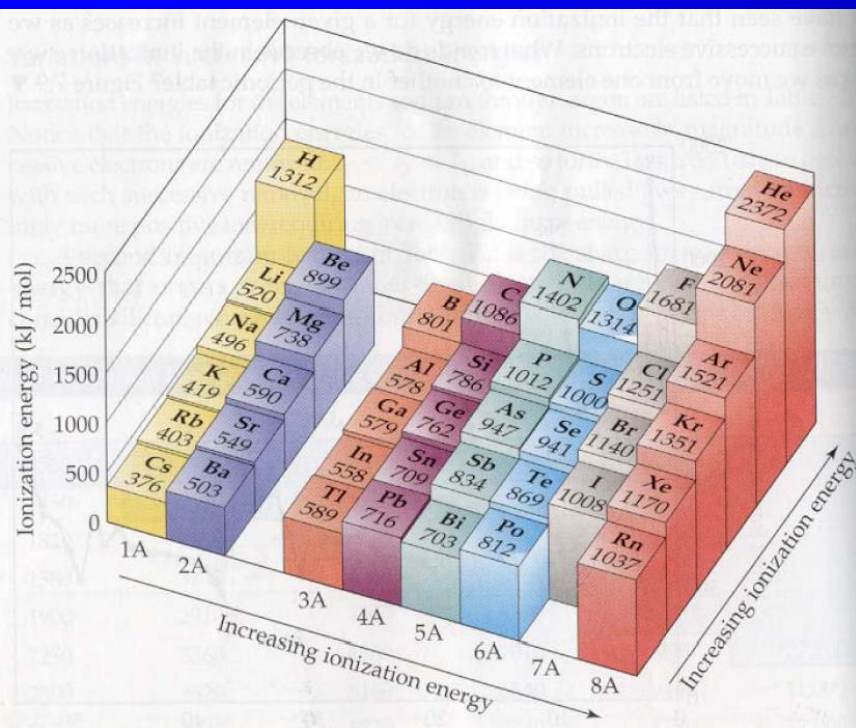
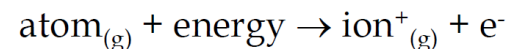

Element/Compound	Ionization Potential (Volts or eV)
He	24.6
Ar	15.8
H <sub>2</sub>	15.4
N <sub>2</sub>	15.6
O <sub>2</sub>	12.1
CO <sub>2</sub>	13.8
CO	14.1
C	11.3
Si	8.2
Fe	7.9
Ni	7.6
Na	5.1
K	4.3
Cs	3.9

# Ionization energies

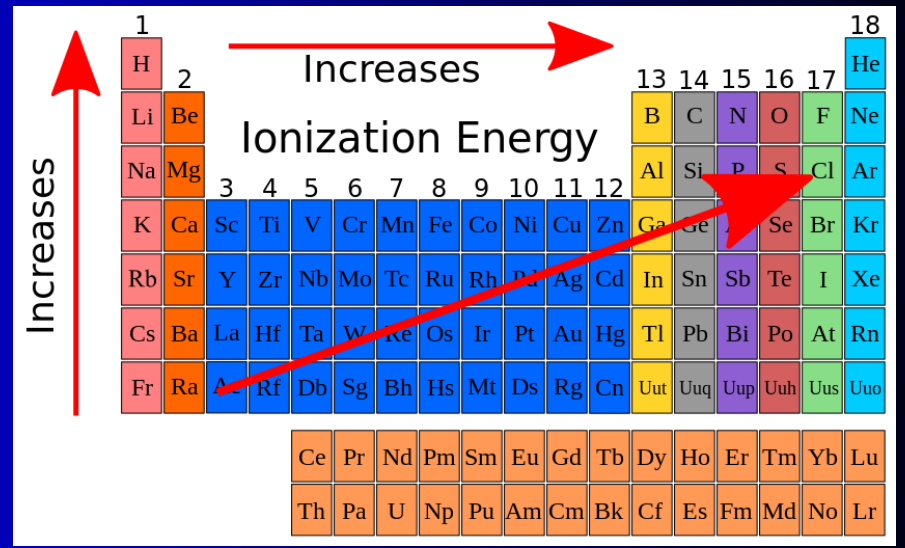
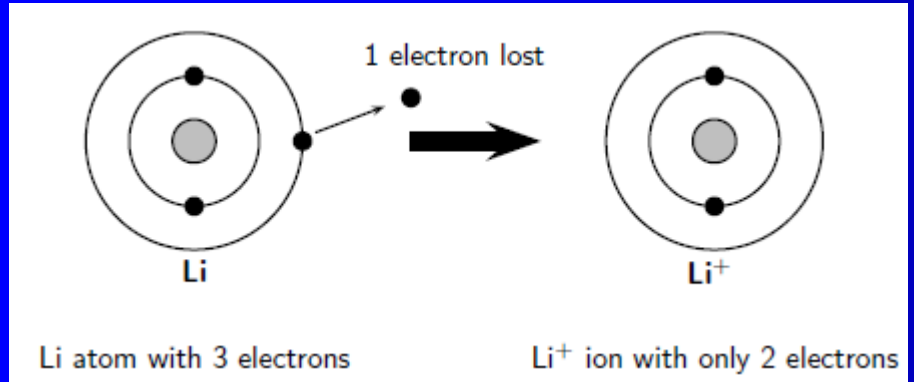
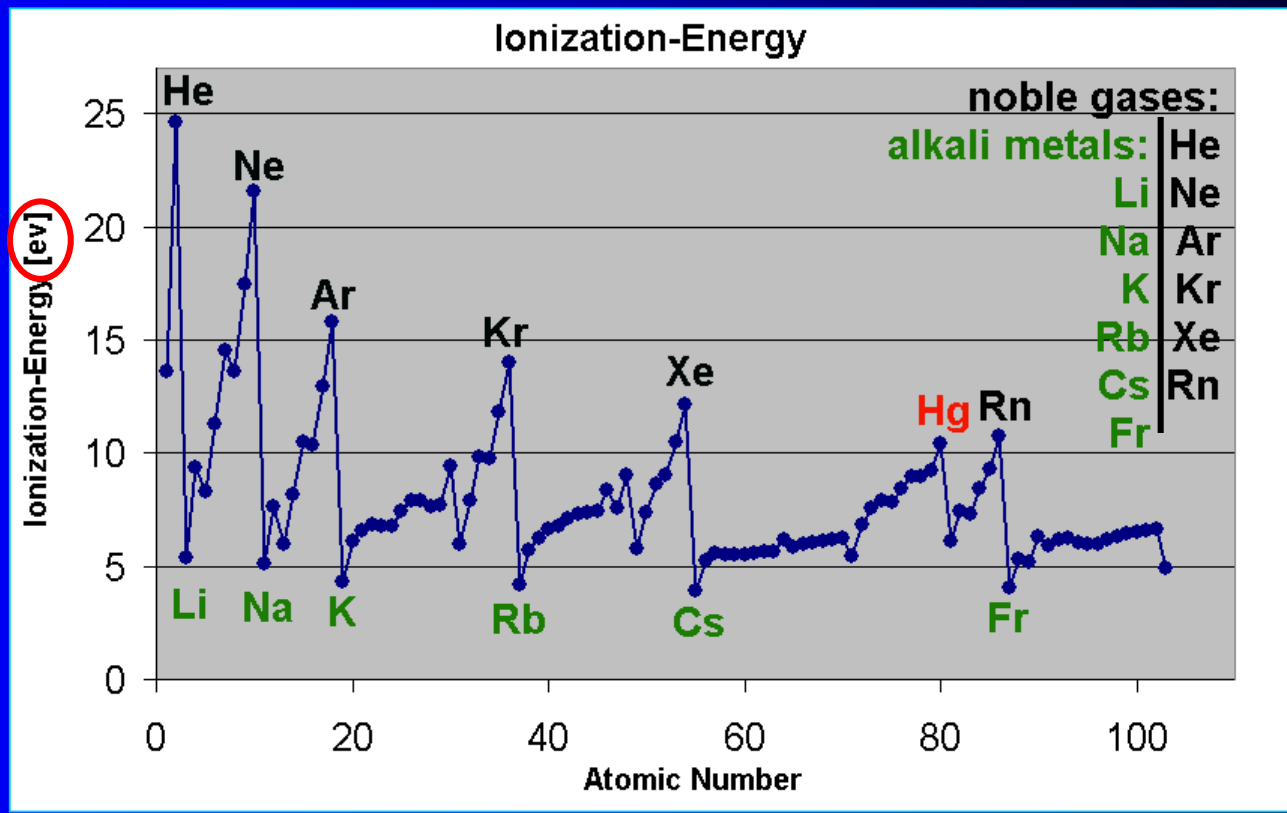







# Ionization energies

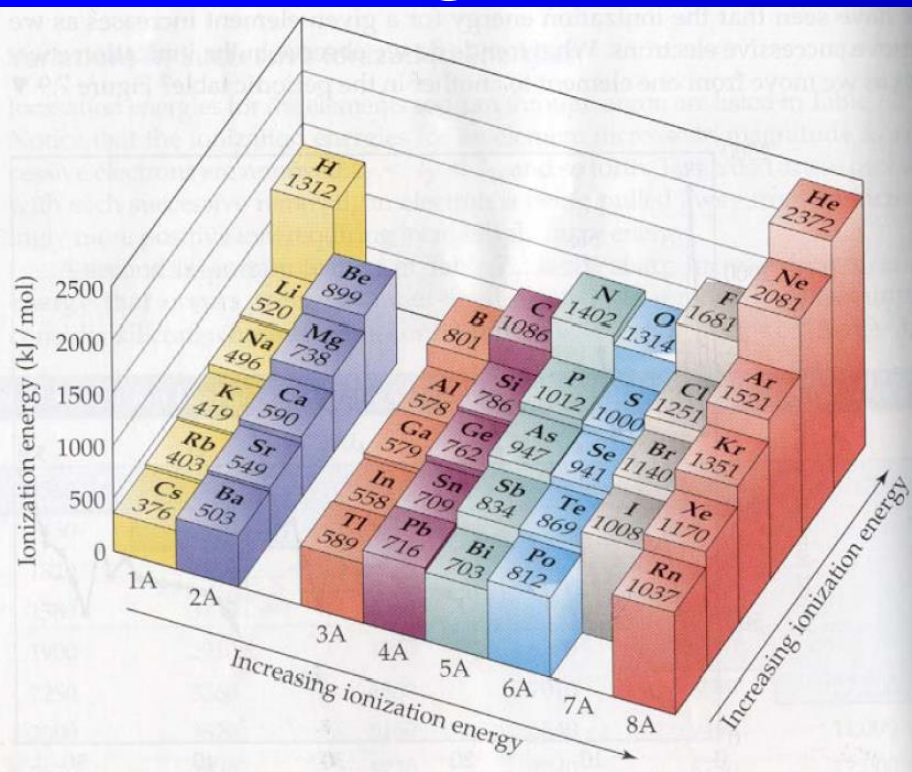

# Electron affinity

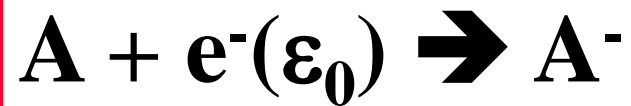
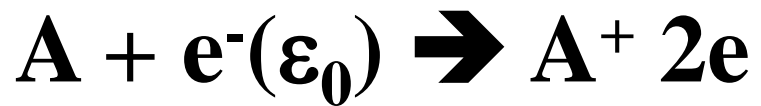
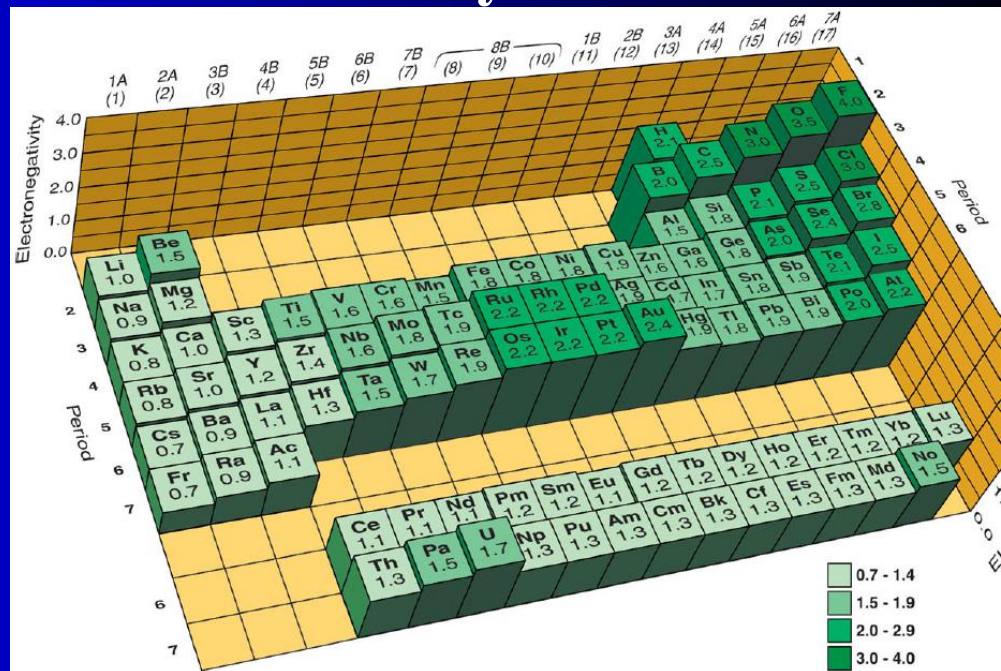

# Ionization cross section – idea of experiment

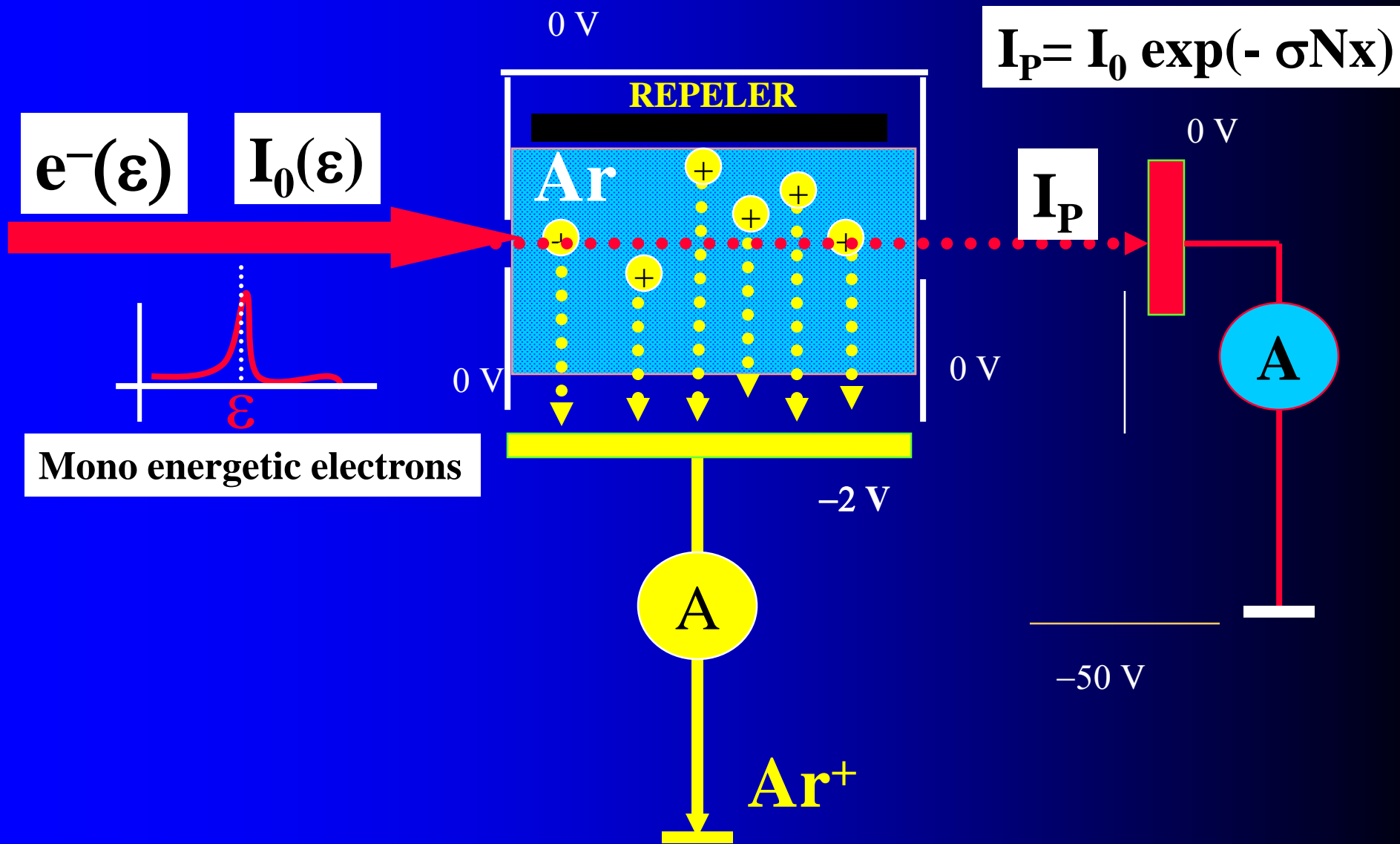

# Electron impact ion source – ion source of mass spectrometer

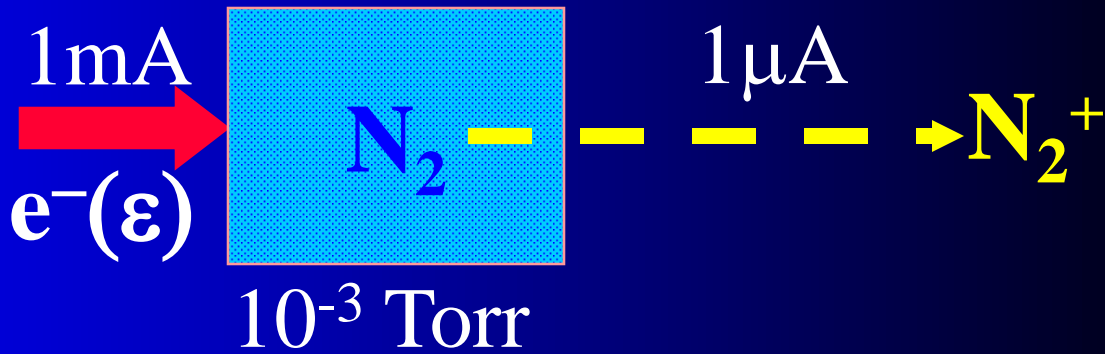
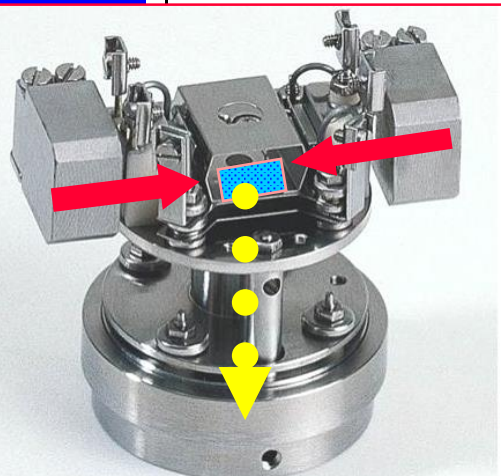
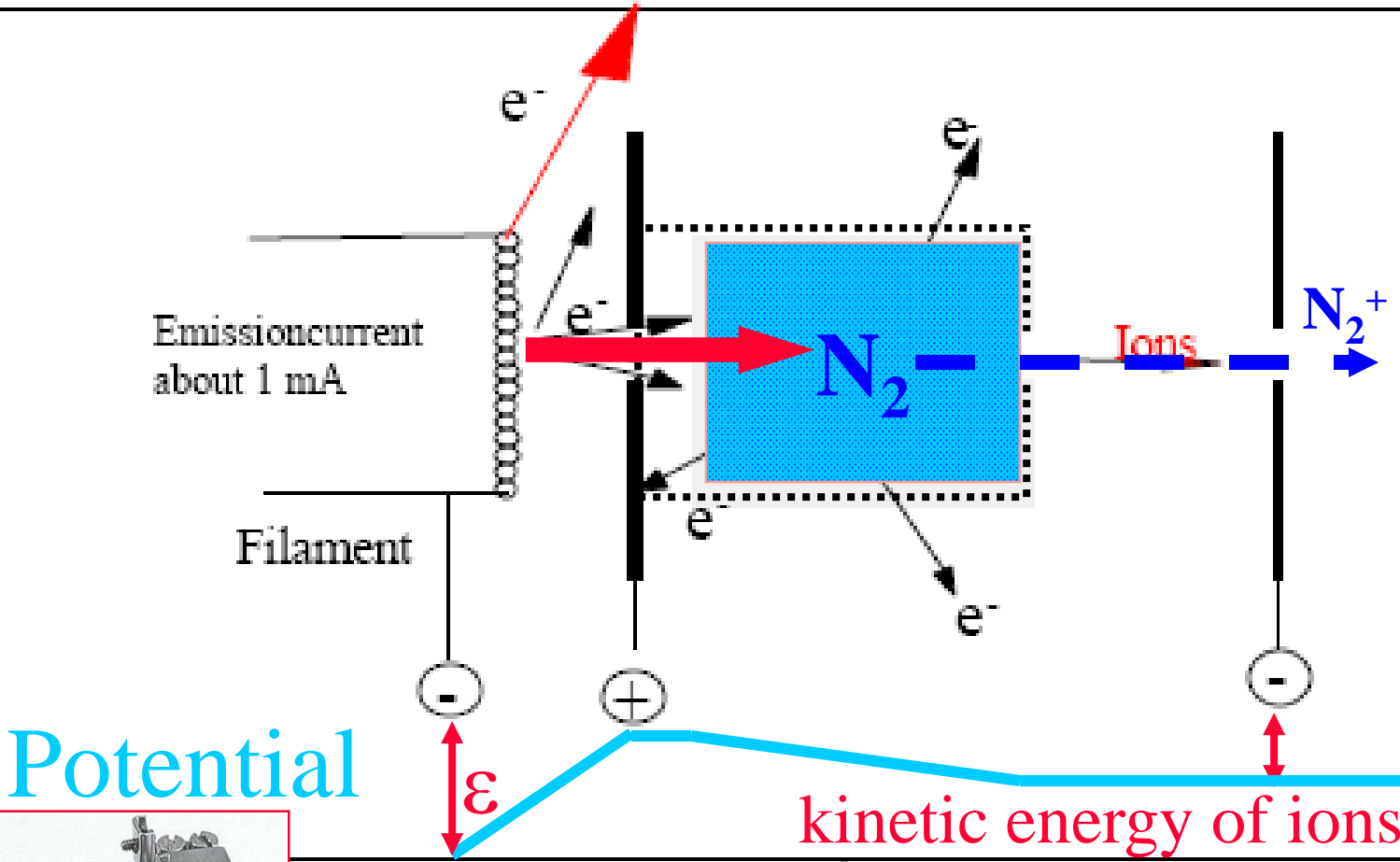

# Electron impact ionization

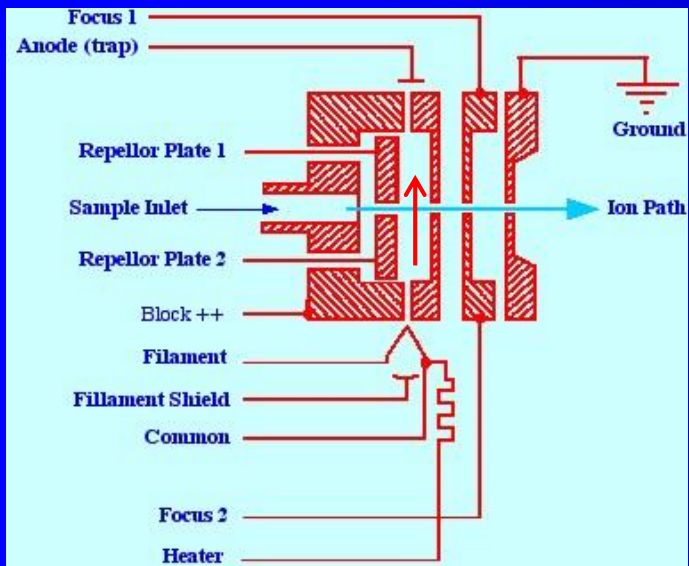
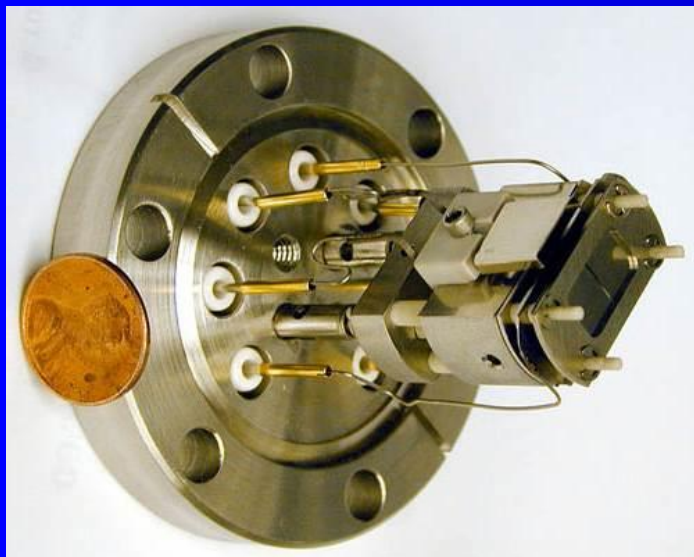
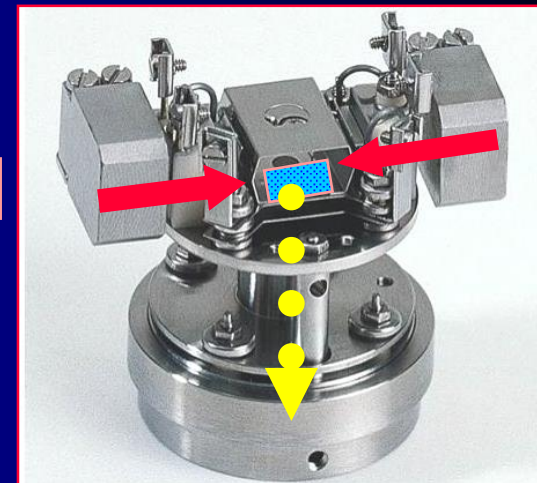
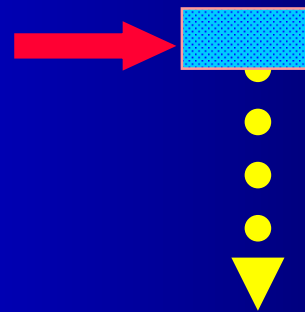
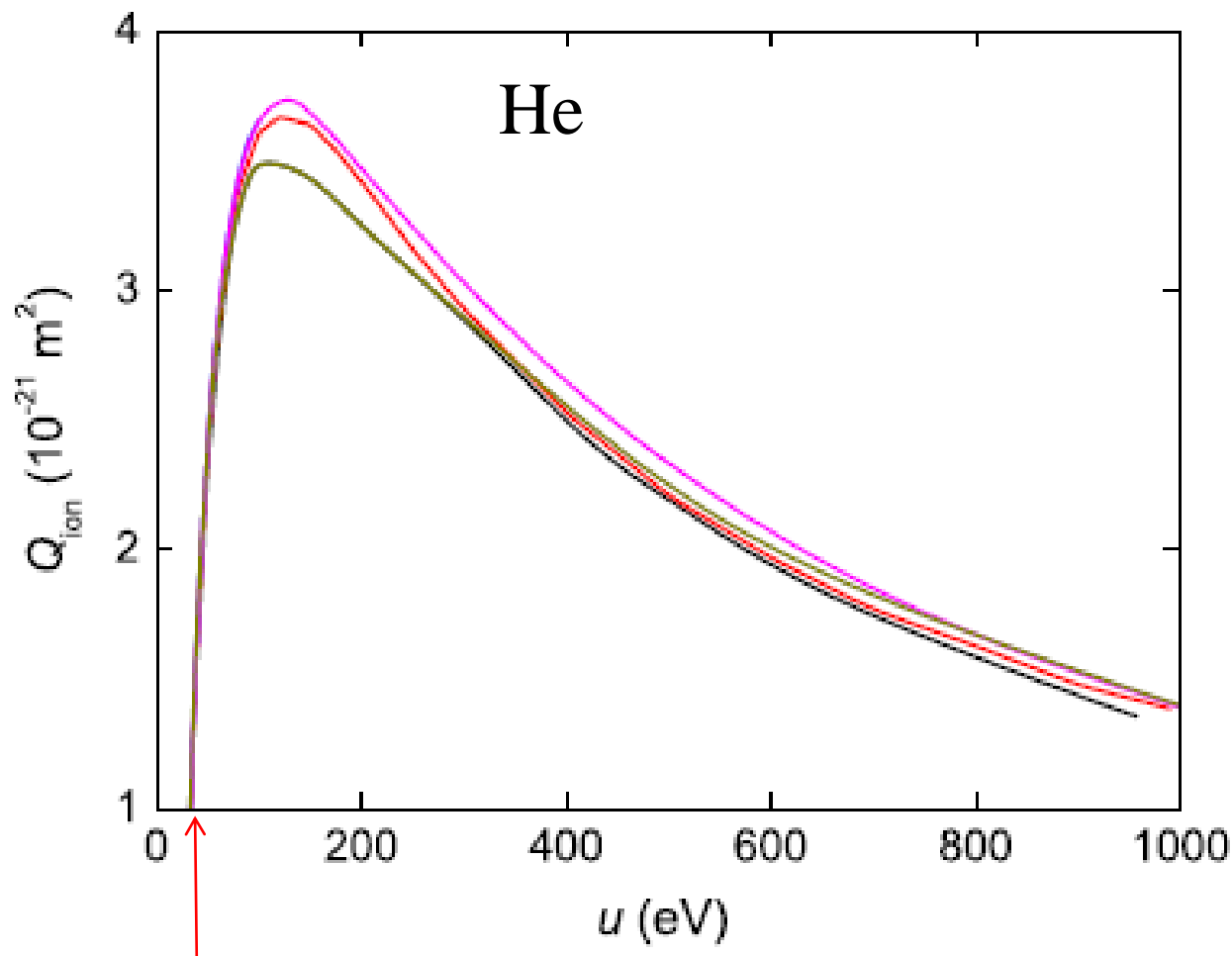

Figure 3. Cross Section of an Electron Impact Source



# He + e<sup>-</sup>

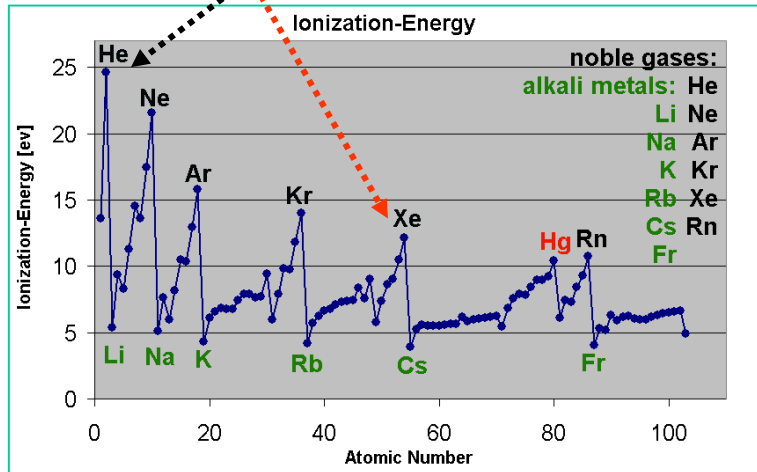
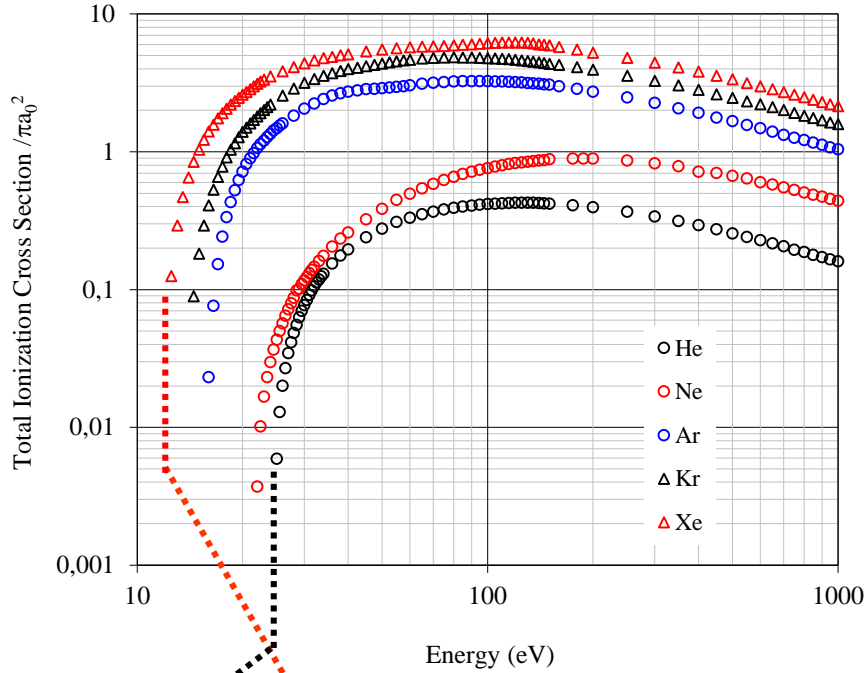

**Figure 4.** Ionization cross sections versus electron energy in helium, from the different databases: BIAGI-v8.9 (—), BIAGI-v7.1 (—), IST-LISBON (—), MORGAN (—), PHELPS (—).



# Standard definition cross section $\sigma$ (in units .... $\sim \dots \text{cm}^2$ )

Experimental results. Rare gases.



Experimental results. Diatomic molecules.

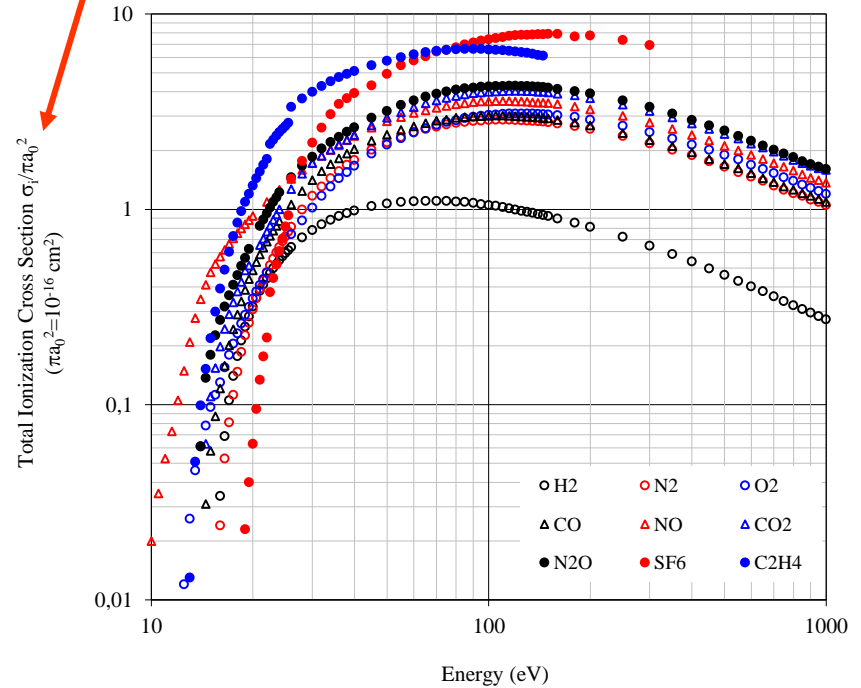

Steinar Stapnes

# Ionization by electron impact

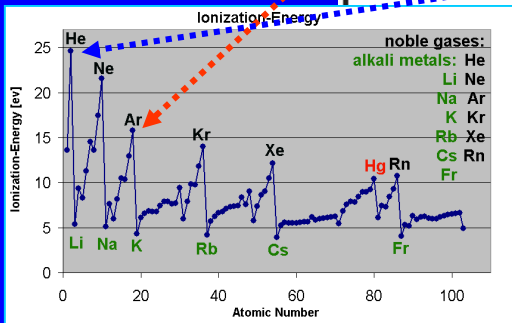
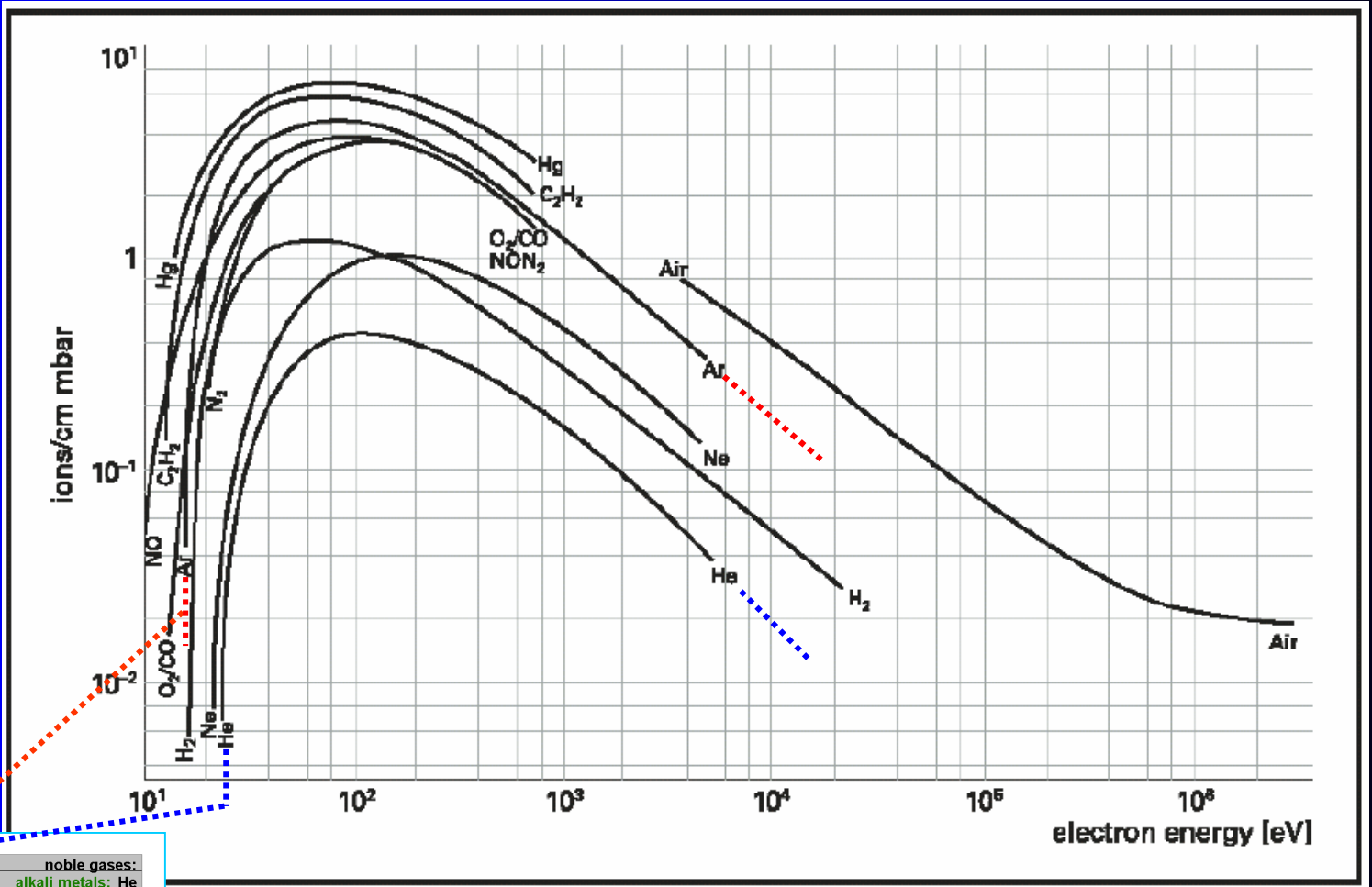



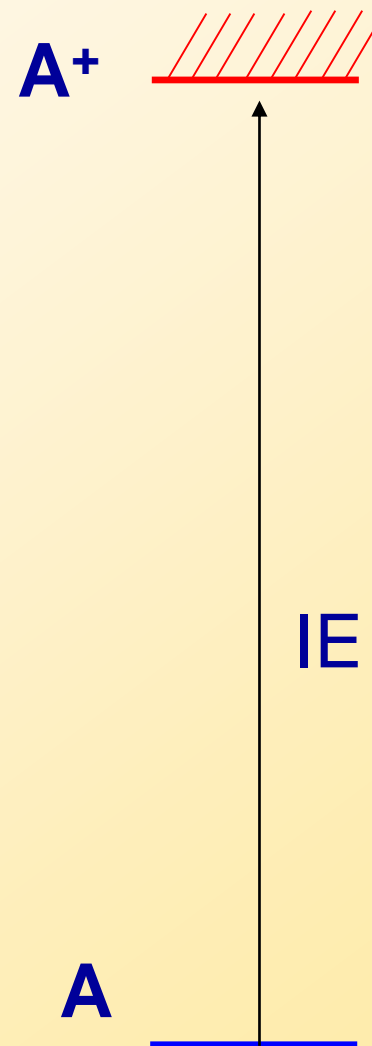

**In case of atoms we have simple situation, the atom in the ground state and the ground state of the ion. The ionization energy is defined as a difference between this two states.**

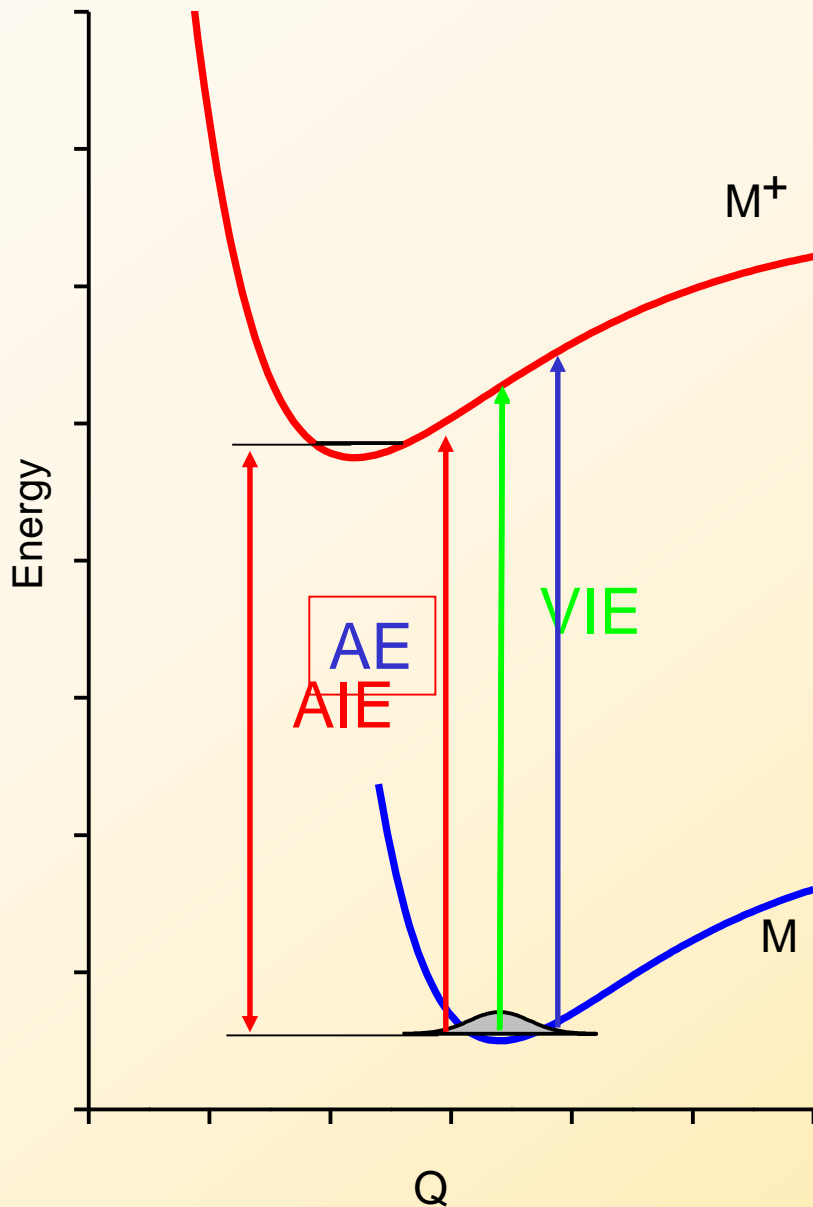

In the molecules is the situation more difficult. We have to work with potential curves or potential energy surfaces and thus the IE depends on the initial geometry of the molecules. For molecule usually two ionization energies are given, vertical IE and adiabatic IE.

**Vertical VIE is defined as the energy necessary to ionise the molecule in the equilibrium geometry**

**Adiabatic AIE is defined as the energy difference between the energies of the ion and molecule in its ground states**

The experiments are sensitive on the lowest energy necessary to ionize molecule and this is called **appearance energy**. This corresponds to the ionization energy at low distances. As the geometry changes in the molecule and the molecular ion are only moderate, often is the AE very close to the AIE.

# Potential Energy diagram for diatomic molecule.

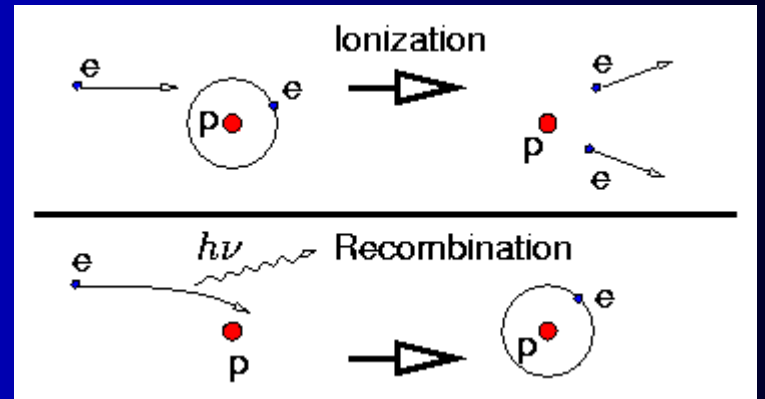
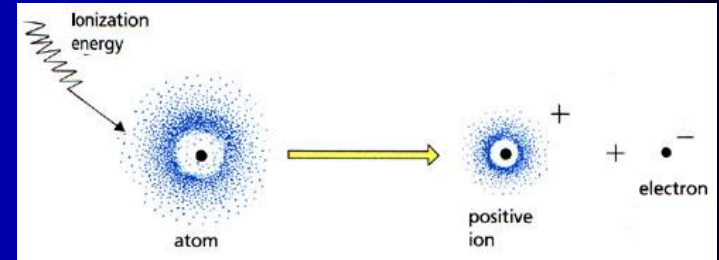
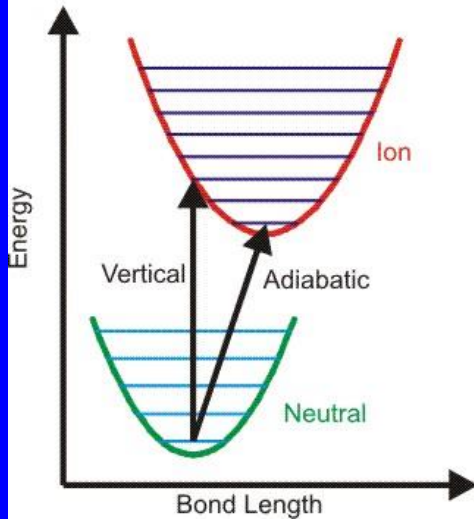

## Ionization Energy, $E_i$

increasing 1<sup>st</sup> Ionization Energy

increasing 1<sup>st</sup> Ionization Energy

1	1A	2	2A	13	3A	14	4A	15	5A	16	6A	17	7A	18	8A																				
1	H	2	He	13	Al	14	Si	15	P	16	S	17	Cl	18	Ar																				
2	Li	Be	3	B	4	C	5	N	6	O	7	F	8	Ne																					
2	Li	Be	3	B	4	C	5	N	6	O	7	F	8	Ne																					
3	Na	Mg	11	Al	12	Si	13	P	14	S	15	Cl	16	Ar																					
3	Na	Mg	11	Al	12	Si	13	P	14	S	15	Cl	16	Ar																					
4	K	Ca	19	Sc	20	Ti	21	V	22	Cr	23	Mn	24	Fe	25	Cu	26	Zn	27	Ga	28	Ge	29	As	30	Se	31	Br	32	Kr					
4	K	Ca	19	Sc	20	Ti	21	V	22	Cr	23	Mn	24	Fe	25	Cu	26	Zn	27	Ga	28	Ge	29	As	30	Se	31	Br	32	Kr					
5	Rb	Sr	37	Y	38	Zr	39	Nb	40	Mo	41	Tc	42	Ru	43	Rh	44	Pd	45	Ag	46	Cd	47	In	48	Sn	49	Sb	50	Te	51	I	52	Xe	
5	Rb	Sr	37	Y	38	Zr	39	Nb	40	Mo	41	Tc	42	Ru	43	Rh	44	Pd	45	Ag	46	Cd	47	In	48	Sn	49	Sb	50	Te	51	I	52	Xe	
6	Cs	Ba	55	La	56	Ce	57	Pr	58	Nd	59	Pm	60	Sm	61	Eu	62	Gd	63	Tb	64	Dy	65	Ho	66	Er	67	Tm	68	Yb	69	Lu			
6	Cs	Ba	55	La	56	Ce	57	Pr	58	Nd	59	Pm	60	Sm	61	Eu	62	Gd	63	Tb	64	Dy	65	Ho	66	Er	67	Tm	68	Yb	69	Lu			
7	Fr	Ra	87	Ac	88	Th	89	Pa	90	U	91	Np	92	Pu	93	Am	94	Cm	95	Bk	96	Cf	97	Es	98	Fm	99	Mn	100	101	102	103	104	105	106
7	Fr	Ra	87	Ac	88	Th	89	Pa	90	U	91	Np	92	Pu	93	Am	94	Cm	95	Bk	96	Cf	97	Es	98	Fm	99	Mn	100	101	102	103	104	105	106
				89	89	90	90	91	91	92	92	93	93	94	94	95	95	96	96	97	97	98	98	99	99	100	100	101	101	102	102	103	103	104	
				89	89	90	90	91	91	92	92	93	93	94	94	95	95	96	96	97	97	98	98	99	99	100	100	101	101	102	102	103	103	104	
				90	90	91	91	92	92	93	93	94	94	95	95	96	96	97	97	98	98	99	99	100	100	101	101	102	102	103	103	104	104	105	105
				90	90	91	91	92	92	93	93	94	94	95	95	96	96	97	97	98	98	99	99	100	100	101	101	102	102	103	103	104	104	105	105
				91	91	92	92	93	93	94	94	95	95	96	96	97	97	98	98	99	99	100	100	101	101	102	102	103	103	104	104	105	105	106	106
				91	91	92	92	93	93	94	94	95	95	96	96	97	97	98	98	99	99	100	100	101	101	102	102	103	103	104	104	105	105	106	106
				92	92	93	93	94	94	95	95	96	96	97	97	98	98	99	99	100	100	101	101	102	102	103	103	104	104	105	105	106	106	107	107
				92	92	93	93	94	94	95	95	96	96	97	97	98	98	99	99	100	100	101	101	102	102	103	103	104	104	105	105	106	106	107	107
				93	93	94	94	95	95	96	96	97	97	98	98	99	99	100	100	101	101	102	102	103	103	104	104	105	105	106	106	107	107	108	108
				93	93	94	94	95	95	96	96	97	97	98	98	99	99	100	100	101	101	102	102	103	103	104	104	105	105	106	106	107	107	108	108
				94	94	95	95	96	96	97	97	98	98	99	99	100	100	101	101	102	102	103	103	104	104	105	105	106	106	107	107	108	108	109	109
				94	94	95	95	96	96	97	97	98	98	99	99	100	100	101	101	102	102	103	103	104	104	105	105	106	106	107	107	108	108	109	109
				95	95	96	96	97	97	98	98	99	99	100	100	101	101	102	102	103	103	104	104	105	105	106	106	107	107	108	108	109	109	110	110
				95	95	96	96	97	97	98	98	99	99	100	100	101	101	102	102	103	103	104	104	105	105	106	106	107	107	108	108	109	109	110	110
				96	96	97	97	98	98	99	99	100	100	101	101	102	102	103	103	104	104	105	105	106	106	107	107	108	108	109	109	110	110	111	111
				96	96	97	97	98	98	99	99	100	100	101	101	102	102	103	103	104	104	105	105	106	106	107	107	108	108	109	109	110	110	111	111
				97	97	98	98	99	99	100	100	101	101	102	102	103	103	104	104	105	105	106	106	107	107	108	108	109	109	110	110	111	111	112	112
				97	97	98	98	99	99	100	100	101	101	102	102	103	103	104	104	105	105	106	106	107	107	108	108	109	109	110	110	111	111	112	112
				98	98	99	99	100	100	101	101	102	102	103	103	104	104	105	105	106	106	107	107	108	108	109	109	110	110	111	111	112	112	113	113
				98	98	99	99	100	100	101	101	102	102	103	103	104	104	105	105	106	106	107	107	108	108	109	109	110	110	111	111	112	112	113	113
				99	99	100	100	101	101	102	102	103	103	104	104	105	105	106	106	107	107	108	108	109	109	110	110	111	111	112	112	113	113	114	114
				99	99	100	100	101	101	102	102	103	103	104	104	105	105	106	106	107	107	108	108	109	109	110	110	111	111	112	112	113	113	114	114
				100	100	101	101	102	102	103	103	104	104	105	105	106	106	107	107	108	108	109	109	110	110	111	111	112	112	113	113	114	114	115	115
				100	100	101	101	102	102	103	103	104	104	105	105	106	106	107	107	108	108	109	109	110	110	111	111	112	112	113	113	114	114	115	115
				101	101	102	102	103	103	104	104	105	105	106	106	107	107	108	108	109	109	110	110	111	111	112	112	113	113	114	114	115	115	116	116
				101	101	102	102	103	103	104	104	105	105	106	106	107	107	108	108	109	109	110	110	111	111	112	112	113	113	114	114	115	115	116	116
				102	102	103	103	104	104	105	105	106	106	107	107	108	108	109	109	110	110	111	111	112	112	113	113	114	114	115	115	116	116	117	117
				102	102	103	103	104	104	105	105	106	106	107	107	108	108	109	109	110	110	111	111	112	112	113	113	114	114	115	115	116	116	117	117
				103	103	104	104	105	105	106	106	107	107	108	108	109	109	110	110	111	111	112	112	113	113	114	114	115	115	116	116	117	117	118	118
				103	103	104	104																												

## Experimental setup:

$E = 0 - 150 \text{ eV}$

FWHM  $\sim 50-140 \text{ meV}$

$I_e \sim 20-100 \text{ nA}$

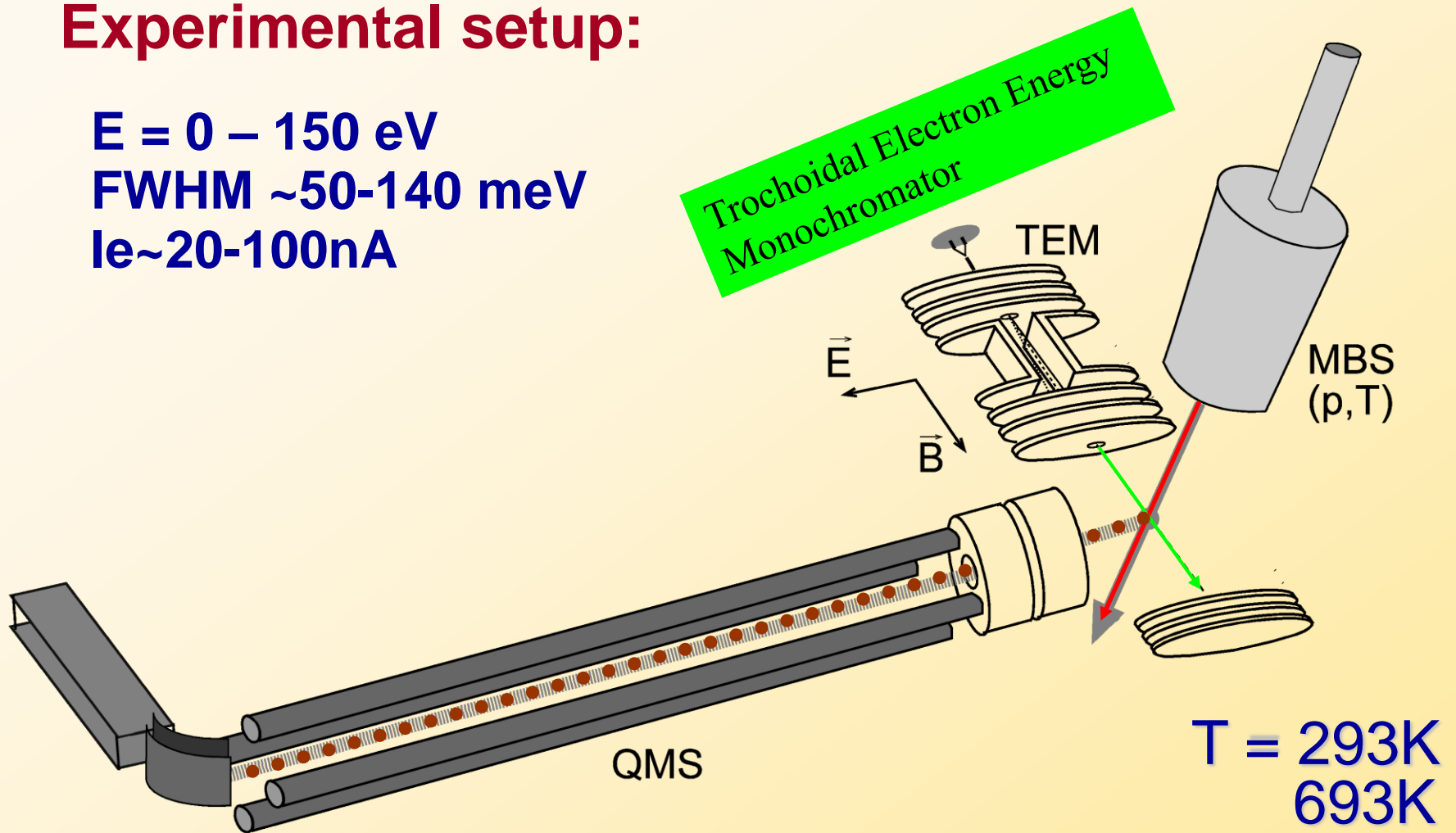

The apparatus consists of TEM, MBS and QMS. The TEM is well known, the FWHM was about 140 meV and the  $I_e \sim 100 \text{ nA}$ . MBS - effusive type, the molecules in the beam have translational, vibrational and rotational temperature identical to the temperature of the MBS.

The mass selected ions are registered as a function of the electron energy.

# Electron impact ionization

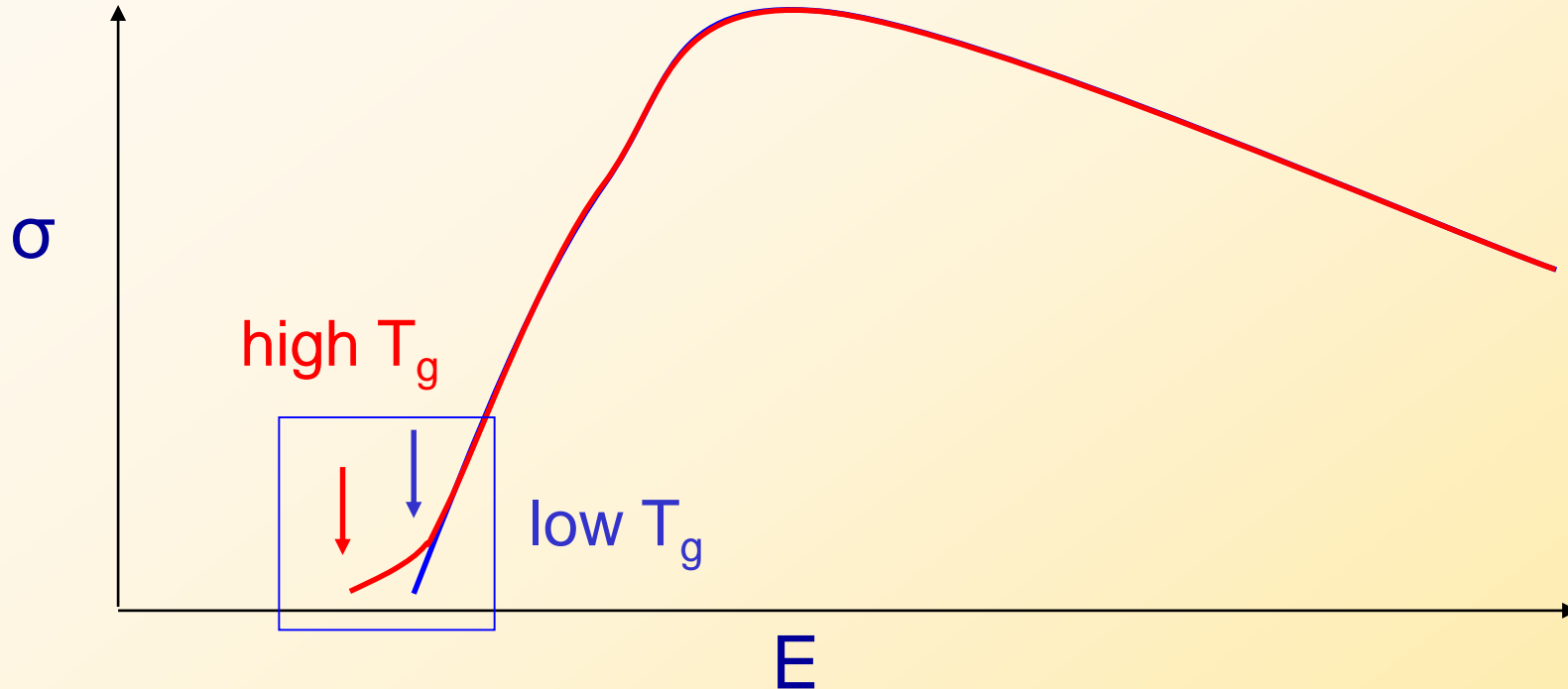

The EII is characterised from point of view of the kinetics by the cross section  
The cross section has a monotonic character with maximum at about 100 eV  
The EII is endothermic reaction with a threshold, called appearance energy of the ions  
In present experiment we have focused on the estimation of the threshold behaviour of the CS,  
estimation of the AE  
At elevated temperatures there are changes in the ion yield in the vicinity of the threshold

Adapted from lecture of prof. Š. Matejčík

# Rate coefficient

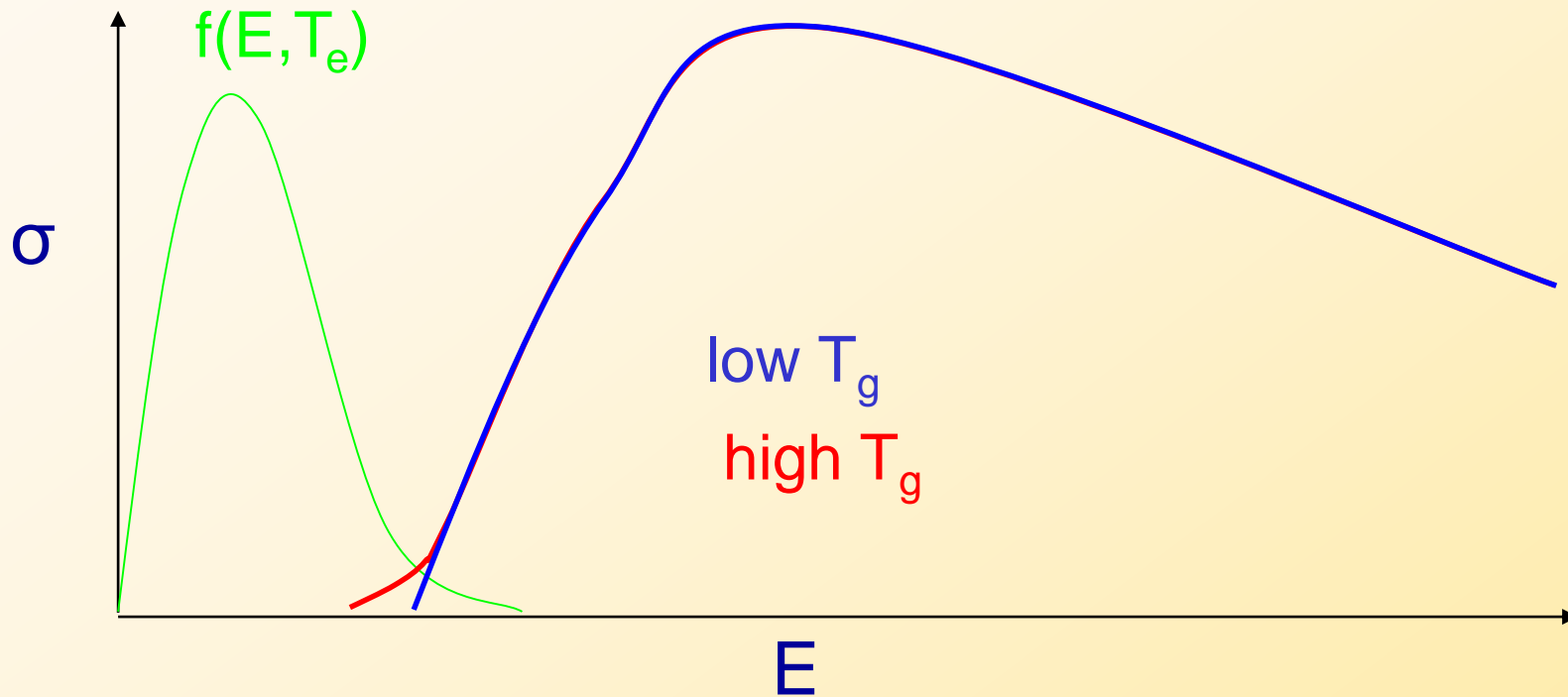

$$\alpha(T, T_e) \propto \int_0^{\infty} \sqrt{E} \sigma_w(E, T) f(E, T_e) dE$$

Two kinds of experiments – cross section measurements

- Threshold measurements – estimation of the AE and studies of the threshold behaviour

## Another definition $\alpha$ in units $\text{cm}^{-1}$

## Mathematical Analysis

When these  $n$  electron move through a distance  $dx$ , they produce another  $dn$  electrons due to collision. Therefore:

$$dn = \alpha n dx$$

$$\frac{dn}{n} = \alpha dx$$

$$\ln n = \alpha x + A$$

Now at  $x = 0$ ,  $n = n_0$ . Therefore,

$$\ln n_0 = A$$

$$\ln n = \alpha x + \ln n_0$$

$$\ln \frac{n}{n_0} = \alpha x$$

$$n = n_0 e^{\alpha x}$$

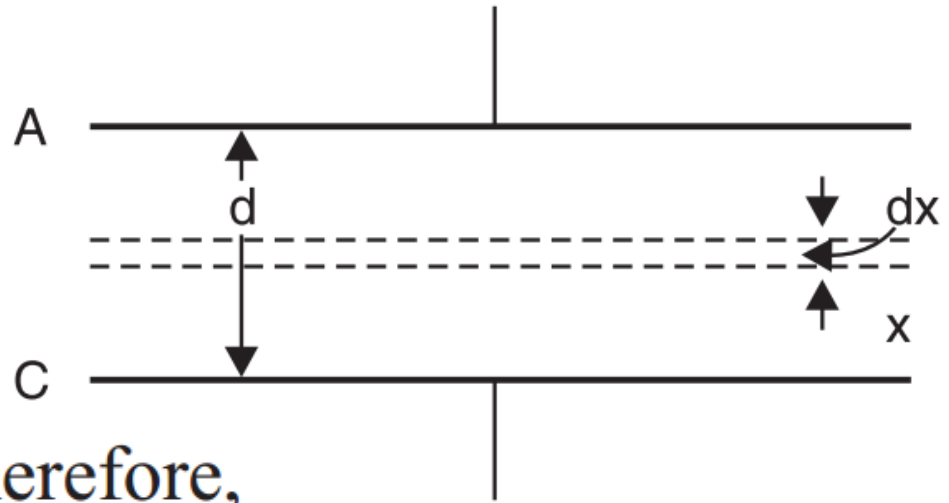



# Another definition $\alpha$ in units $\text{cm}^{-1}$

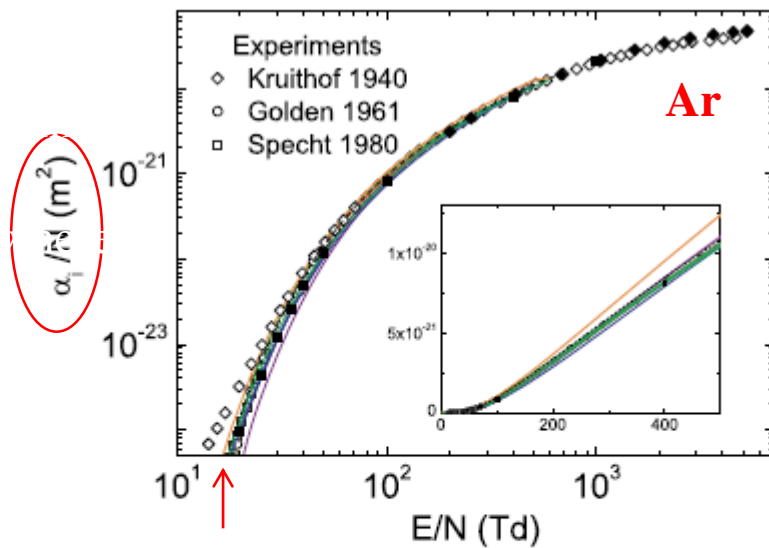

**Figure 8. Measured and calculated reduced ionization coefficients.** The solid lines are results from two-term Boltzmann calculations and the solid symbols (■) are from the Monte Carlo calculations using MAGBOLTZ (Biagi 2011). The colour code is BIAGI-v8.9 (—); BSR (—); HAYASHI (—); IST-LISBON (—); MORGAN (—); PHELPS (—); PUECH (—). The measurements are referenced in the text.

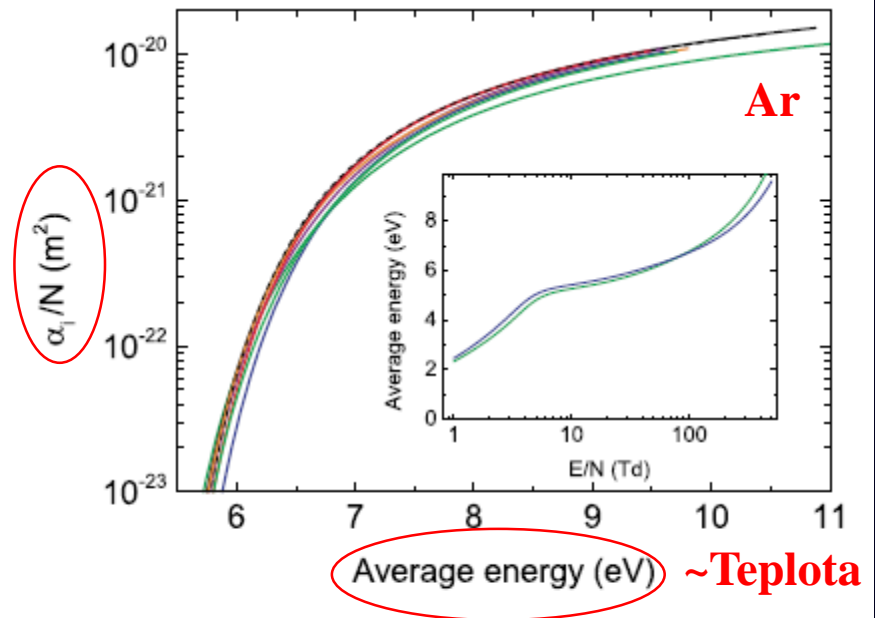

**Figure 9. Reduced ionization coefficient versus average electron energy, calculated using a two-term Boltzmann solver.** The inset shows the average energy versus  $E/N$ , and the colour code is BIAGI-v8.9 (—); BIAGI-v7.1 (- - -); BSR (—); HAYASHI (—); IST-LISBON (—); MORGAN (—); PHELPS (—); PUECH (—).

Approximate computed curves showing the percentage of electron energy going to various actions at a given  $X/p$  (V/cm/mmHg)

Elastic: loss to elastic impact

Excitation: excitation of electron levels, leading to light emission and metastable states

Ionization: ionization by direct impact

Kinetic: average kinetic energy divided by their “temperature”

Vibration: energy going to excitation of vibrational levels

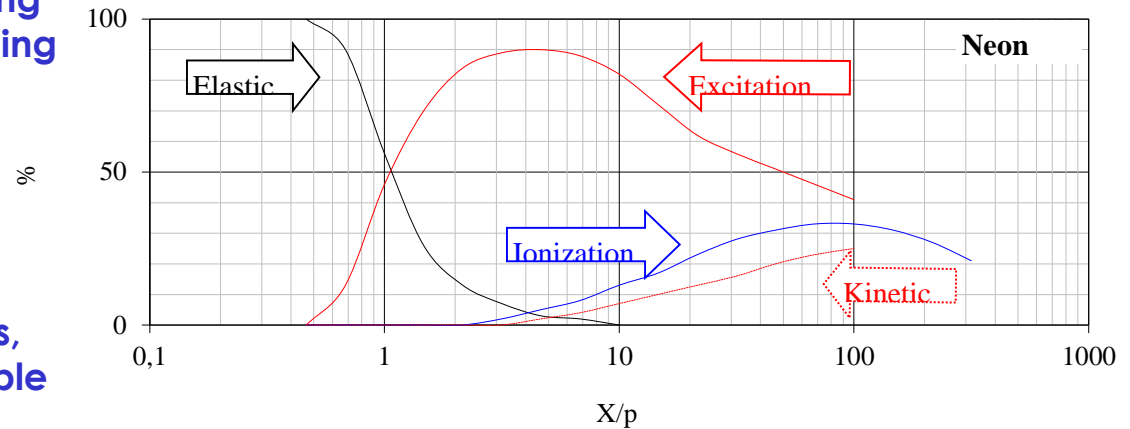

Add a sprinkling of argon

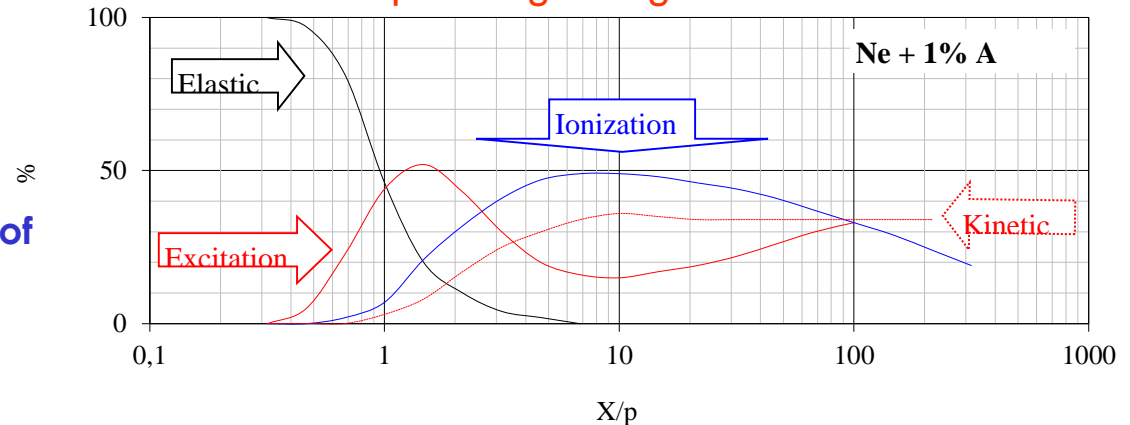

## 2.3. Electron impact ionization

The electron impact ionization is the most fundamental ionization process for the operation of ion sources.

### Why?

- The cross section for the impact ionization is by orders of magnitudes higher than the cross section for the photo ionization.
- The cross section depends on the mass of the colliding particle. Since the energy transfer of a heavy particle is lower, a proton needs for an identical ionization probability an ionization energy three orders of magnitudes higher than an electron

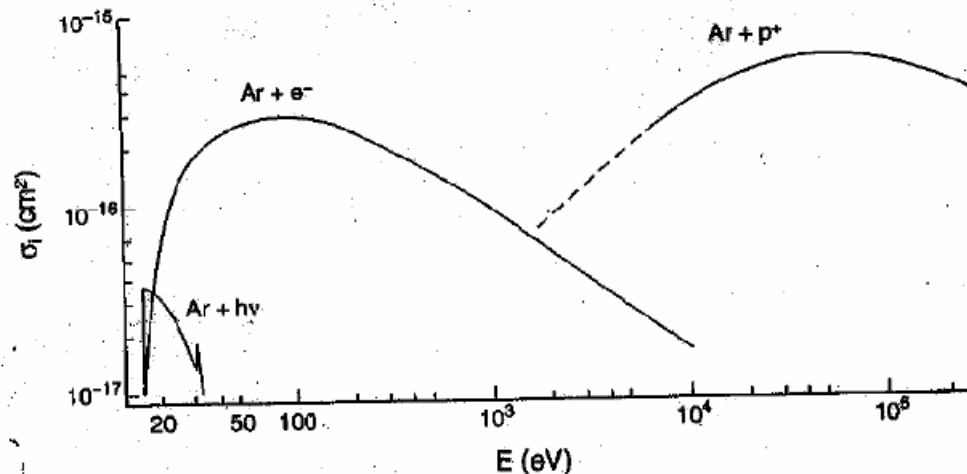

**FIGURE 4**  
Ionization cross sections as functions of energy for ionizing collisions with fast electrons, protons, and photons. (From Winter, H., in *Experimental Methods in Heavy Ion Physics*, Springer-Verlag, 1977, p. 1099. With permission.)

# p + H<sub>2</sub> Ionization Cross Section

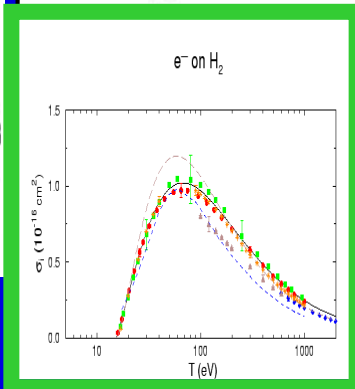
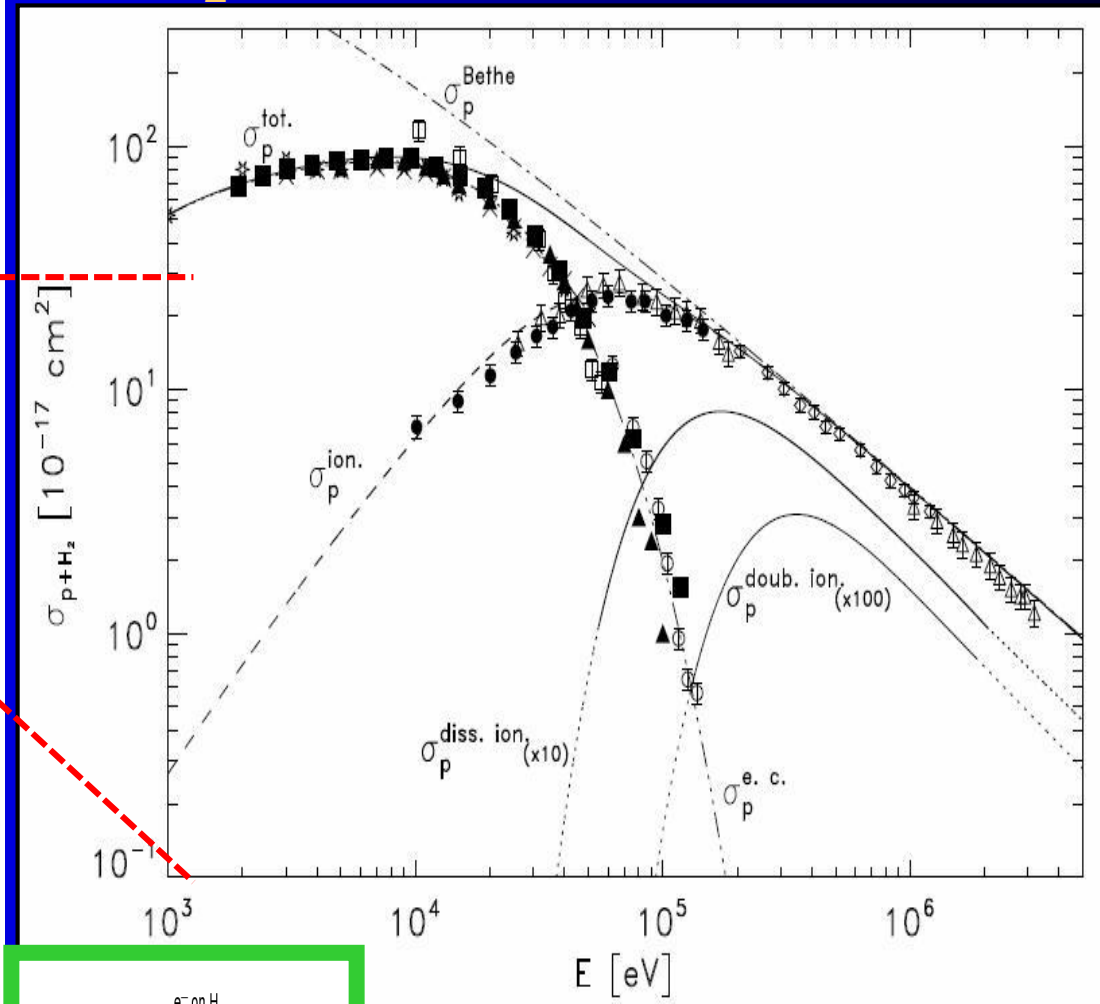
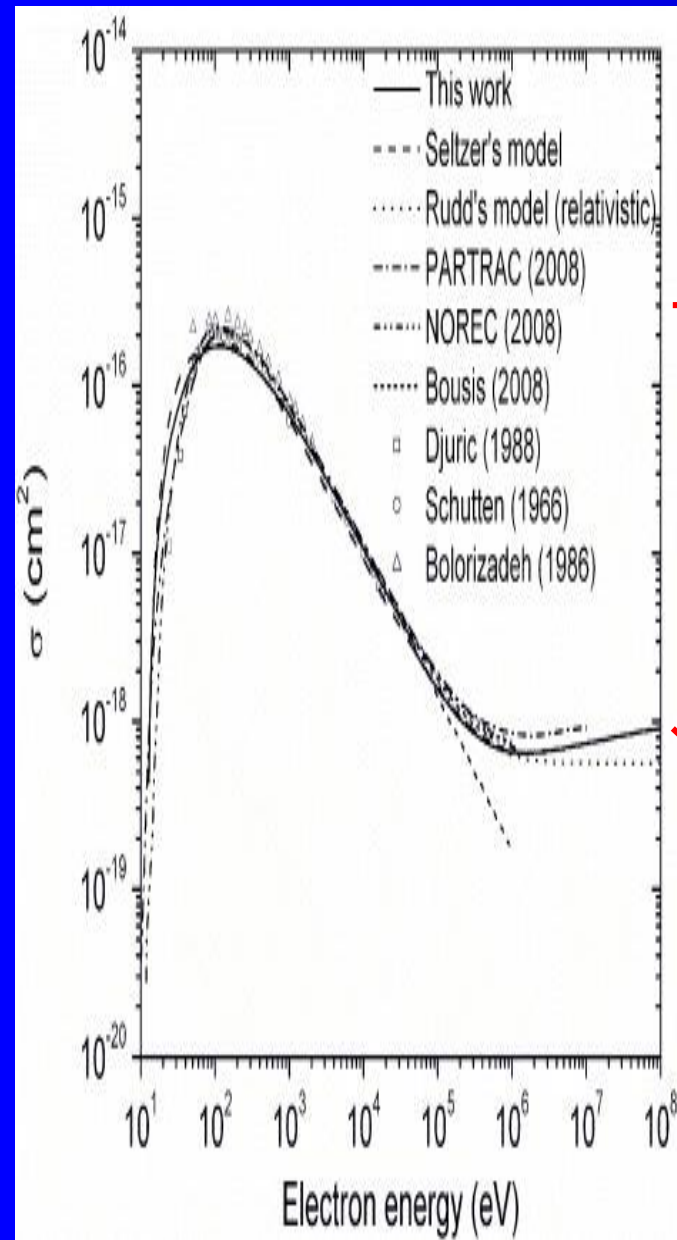

Padovani et al. 2009, A&A, 501, 619

# H<sub>2</sub> + e

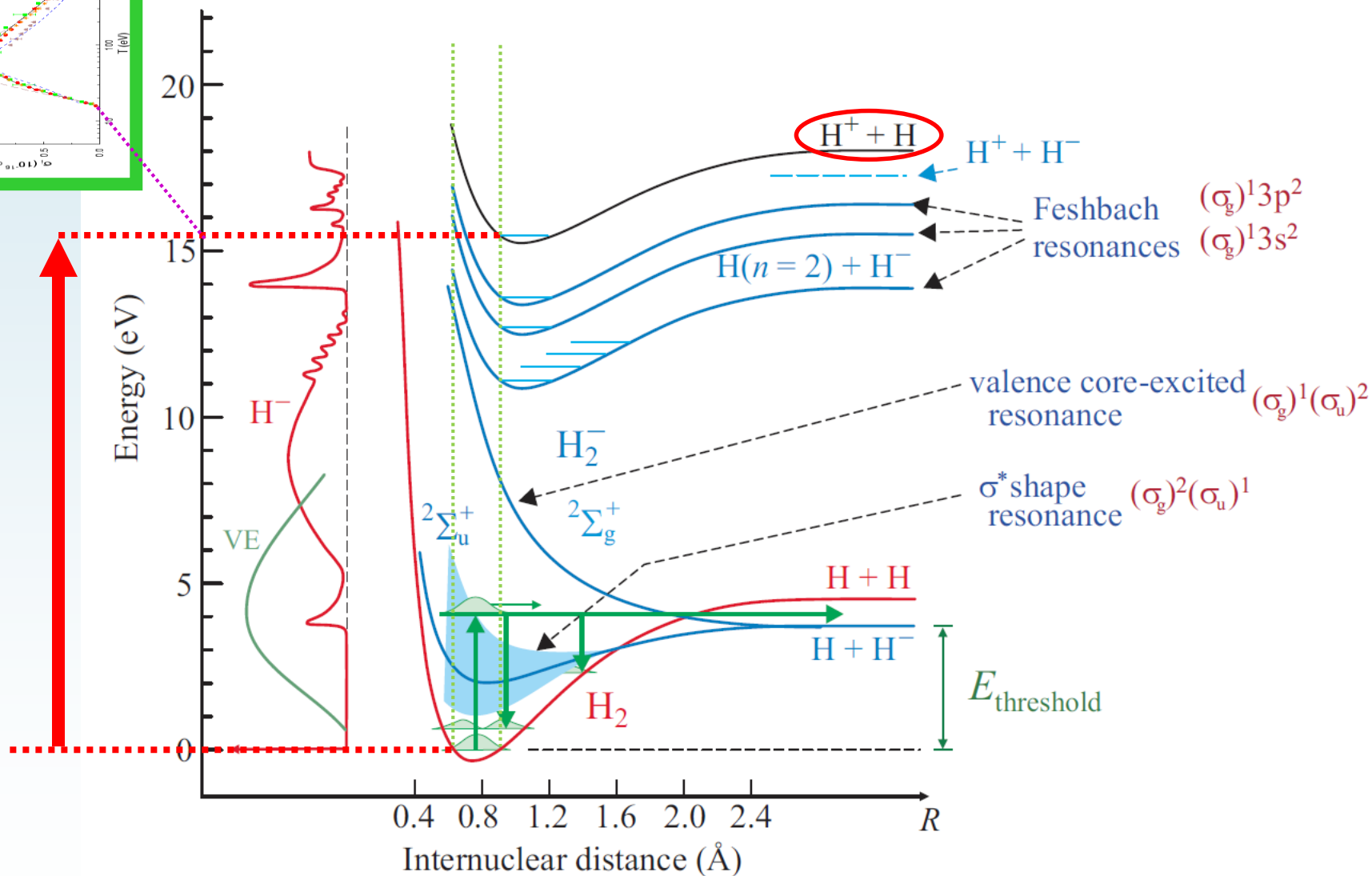
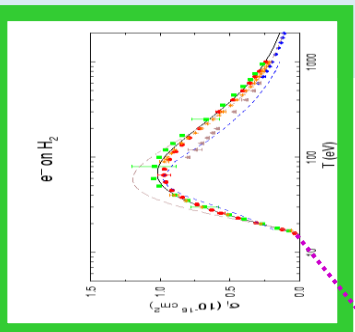

# Cross sections for vibrational excitation, dissociation, ionization...H<sub>2</sub>

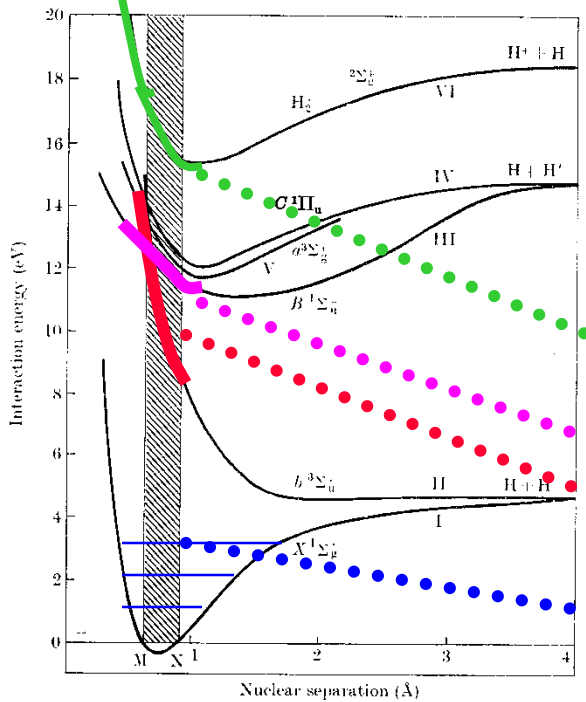

FIG. 13.1. Potential energy curves for electronic states of H<sub>2</sub> and H<sub>2</sub><sup>+</sup> lying within 20 eV of the ground state.

- H<sub>2</sub> + e → H<sub>2</sub>(v) + e ..... **Vibrational excitation**  
 → H + H + e ..... **Dissociation**  
 → H<sub>2</sub><sup>\*</sup> + hv + e ... **Photon excitation**  
 → H<sub>2</sub><sup>+</sup> + e + e ..... **Ionization**  
 → H<sup>+</sup> + H + e + e **Dissociative Ionization**

**H<sub>2</sub> + e**

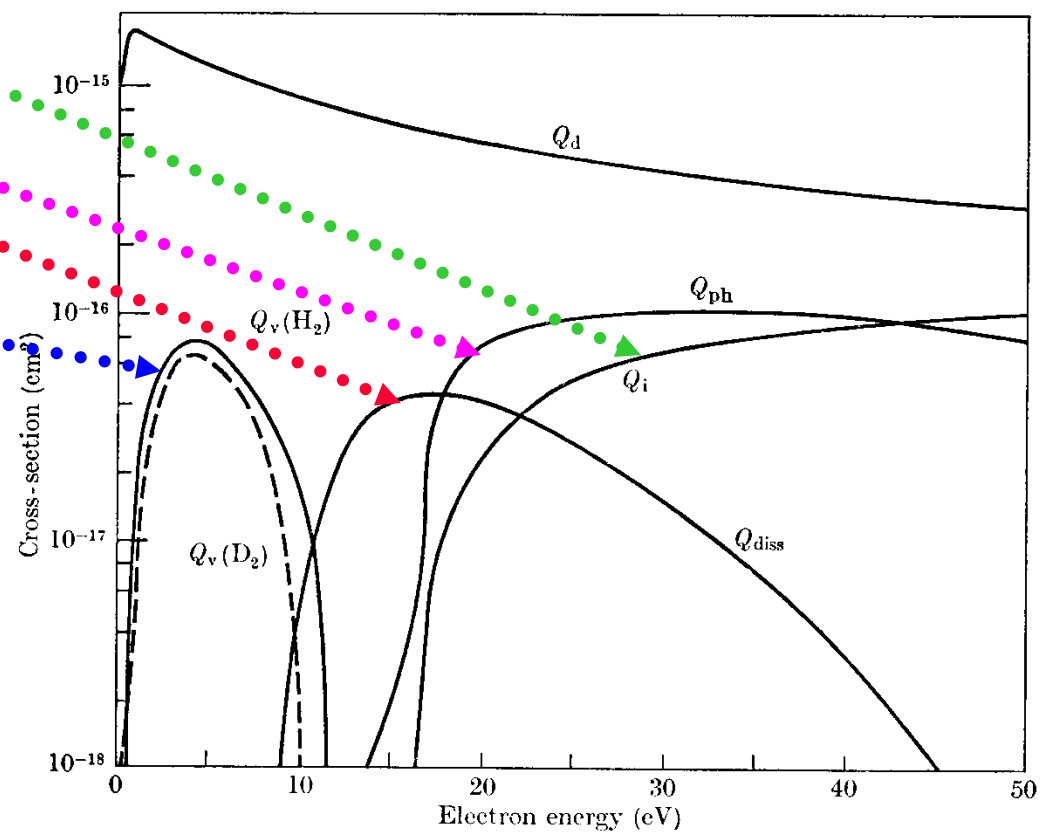
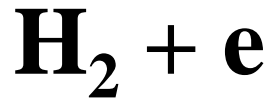

FIG. 13.37. Cross-sections assumed by Engelhardt and Phelps in their analysis of swarm data in H<sub>2</sub> and D<sub>2</sub> for electrons of characteristic energy greater than 1 eV. Q<sub>d</sub> momentum-transfer cross-section, Q<sub>i</sub>, ionization cross-section, Q<sub>diss</sub> dissociation cross-section, Q<sub>ph</sub> photon excitation cross-section, Q<sub>v</sub> vibrational excitation cross-section (— H<sub>2</sub>, --- D<sub>2</sub>).



## Potential Energy Surface Description of the Ionization of $\text{H}_2$

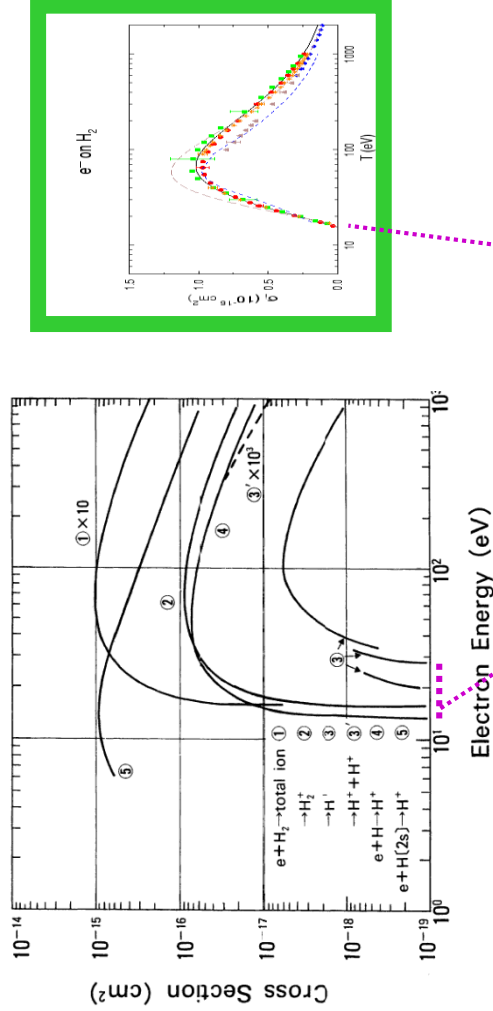
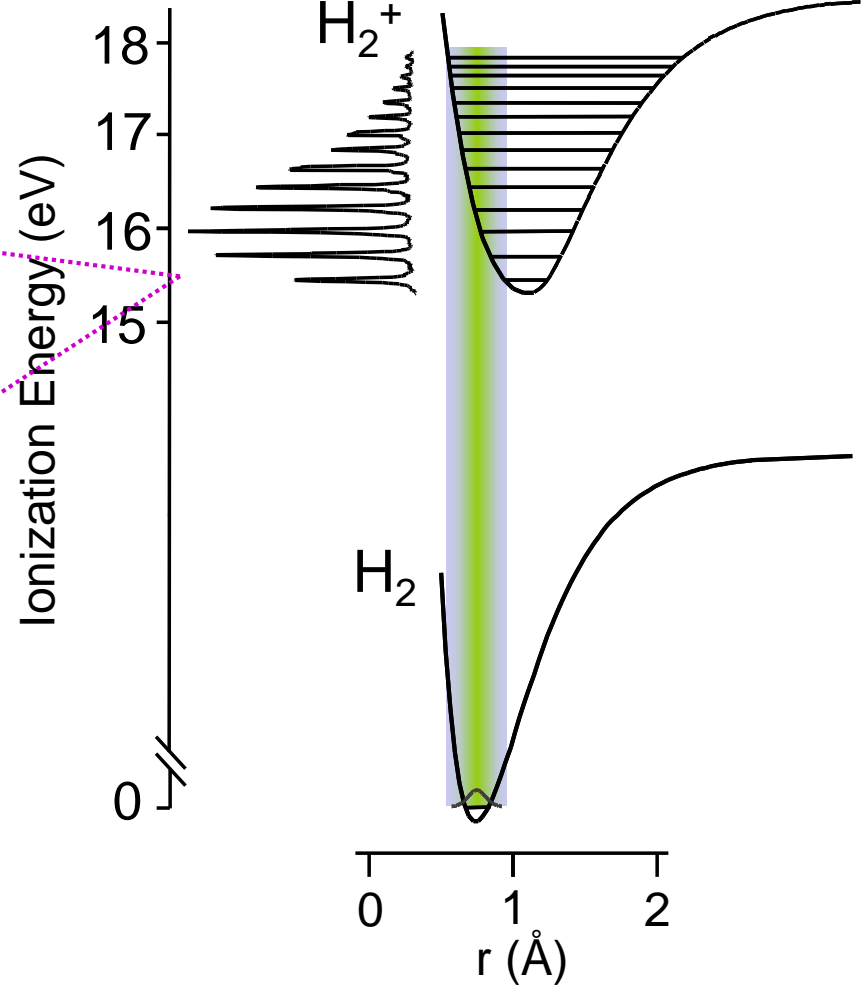
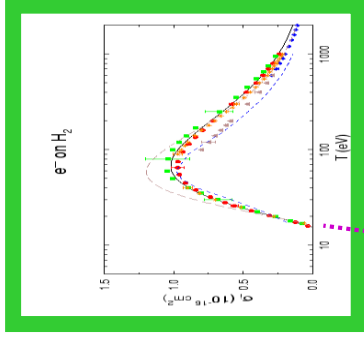

FIG. 16. Cross sections of the production for total ion, molecular hydrogen ions, protons and double protons. Those of proton production from  $\text{H}$  and  $\text{H}(2s)$  are also shown for comparison (see Ref. 1,2). Note that the short curves, for proton production at lower energies, correspond to the processes via  $2s$  (near-zero energy protons) and  $2s$  (repulsive state), respectively.





# Details of interaction of electron with H<sub>2</sub> (1990)

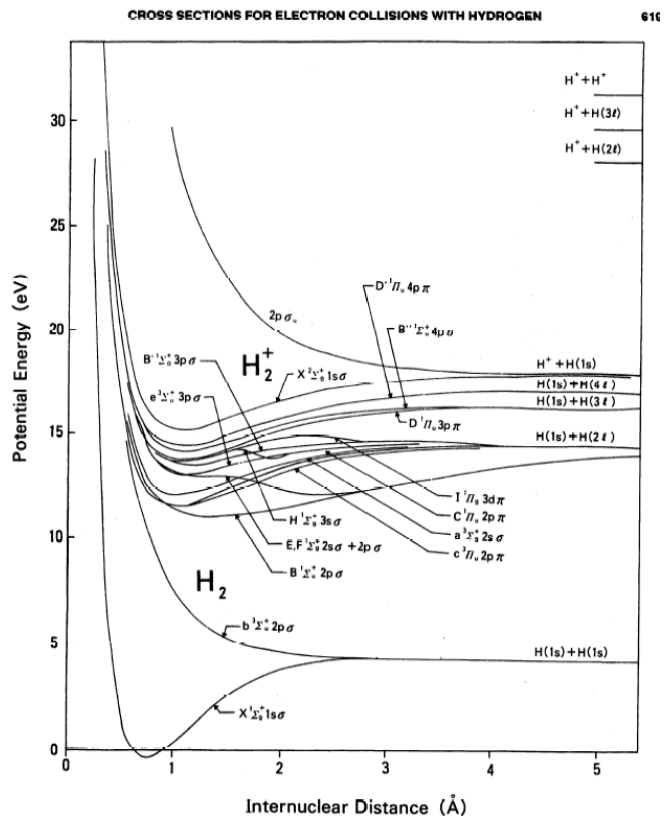
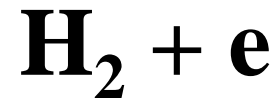

FIG. 1. Some important energy levels of molecular hydrogen and molecular ion (see Ref. 5).

## Cross Sections and Related Data for Electron Collisions with Hydrogen Molecules and Molecular Ions<sup>(a)</sup>

H. Tawara, Y. Itikawa,<sup>(b)</sup> H. Nishimura,<sup>(c)</sup> and M. Yoshino<sup>(d)</sup>

National Institute for Fusion Science,<sup>(e)</sup> Nagoya 464-01, Japan

(Received July 5, 1989; revised manuscript received November 1, 1989)

Data are compiled and evaluated for collision processes of excitation, dissociation, ionization, attachment, and recombination of hydrogen molecules and molecular ions (H<sub>2</sub><sup>+</sup>, H<sub>3</sub><sup>+</sup>) by electron impact as well as for properties of their collision products.

Key words: electron impact; hydrogen molecule; hydrogen molecular ion; scattering; elastic integral; vibrational excitation; rotational excitation; dissociation; ionization; photon emission; cross section.

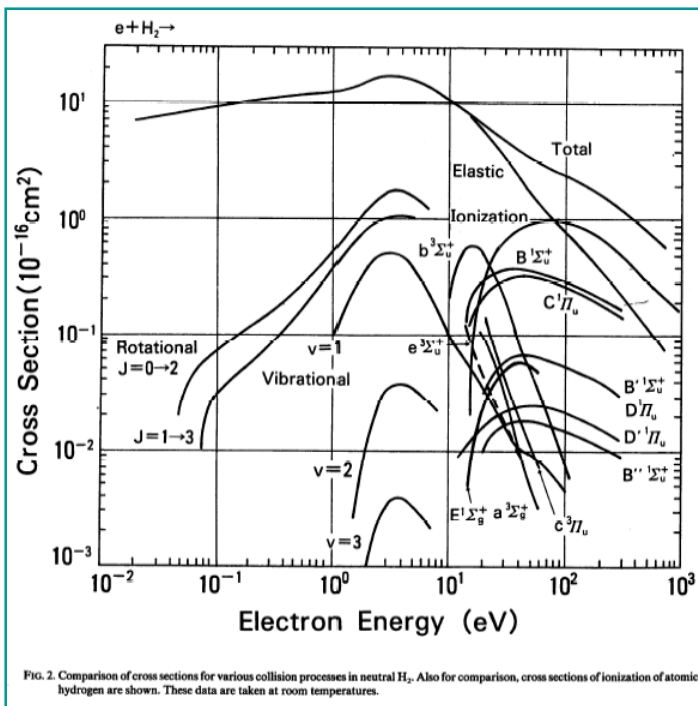

FIG. 2. Comparison of cross sections for various collision processes in neutral H<sub>2</sub>. Also for comparison, cross sections of ionization of atomic hydrogen are shown. These data are taken at room temperatures.

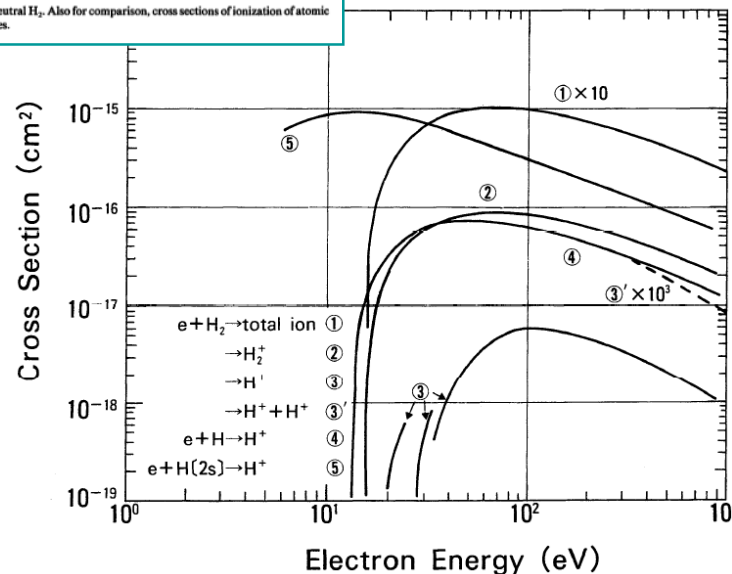

FIG. 16. Cross sections of the production for total ion, molecular hydrogen ions, protons and double protons. Those of proton production from H and H(2s) are also shown for comparison (see Ref. 125). Note that the short curves, for proton production at lower energies, correspond to the processes via <sup>2</sup>Σ<sub>u</sub> (near-zero energy protons) and <sup>2</sup>Σ<sub>u</sub> (repulsive state), respectively.

# Partial cross section for excitation

# NO

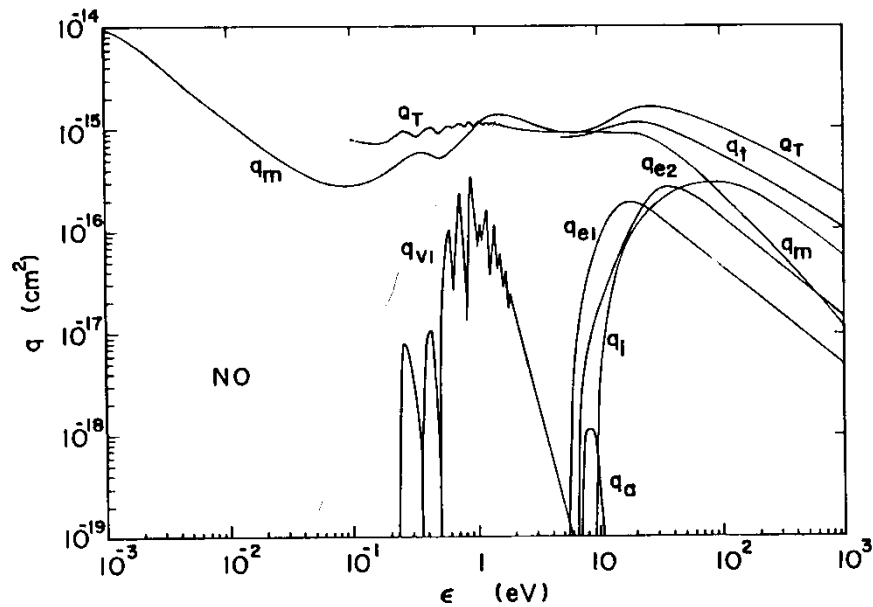

Fig. 4. Cross-section set for NO (1986).

# NH<sub>3</sub>

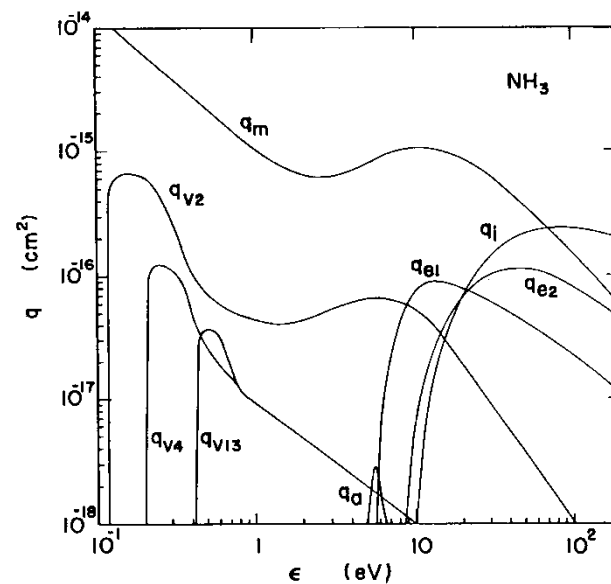
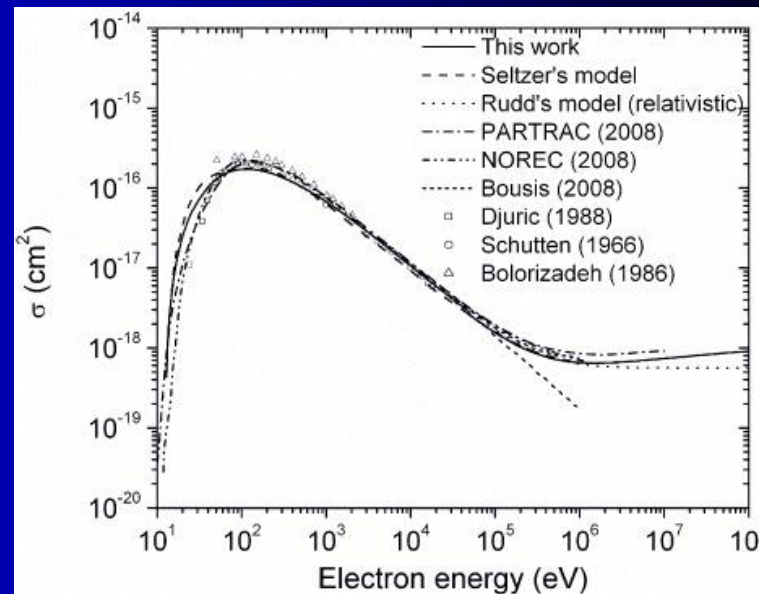
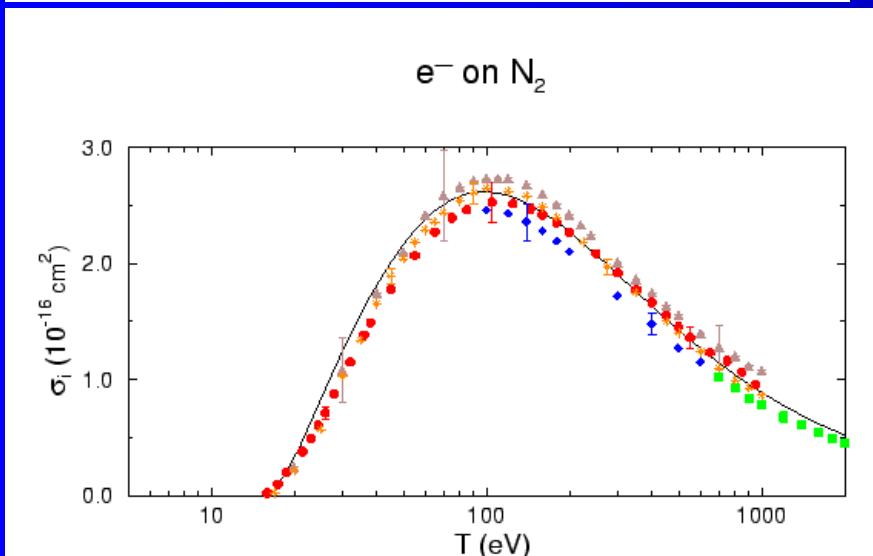
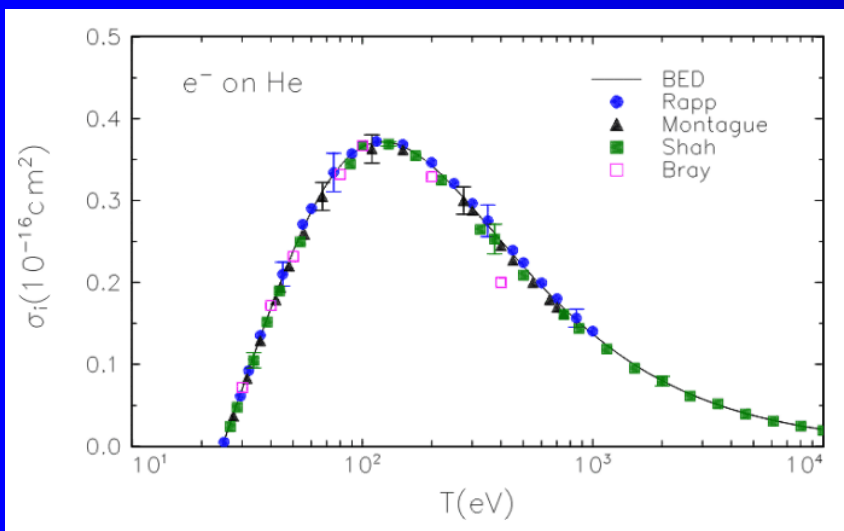

Fig. 6. Electron collision cross-section set for NH<sub>3</sub> (1986).

# Ionization cross section He and N<sub>2</sub>

## Electron impact



BEB W. Hwang, Y.-K. Kim and M.E. Rudd,  
J. Chem. Phys. **104**, 2956 (1996).

New J. Phys. **11** (2009) 063047  
doi:10.1088/1367-2630/11/6/063047

Cross sections for the interactions of 1 eV–100 MeV electrons in liquid water and application to Monte-Carlo simulation of HZE radiation tracks

Ianik Plante<sup>1,2</sup> and Francis A Cucinotta<sup>1</sup>

# Life is not so simple – Total ionization cross section

## Electron Interactions with CF<sub>4</sub>

L. G. Christophorou,<sup>a)</sup> J. K. Olthoff, and M. V. V. S. Rao  
National Institute of Standards and Technology, Gaithersburg, Maryland 20899-0001

J. Phys. Chem. Ref. Data, Vol. 25, No. 5, 1996

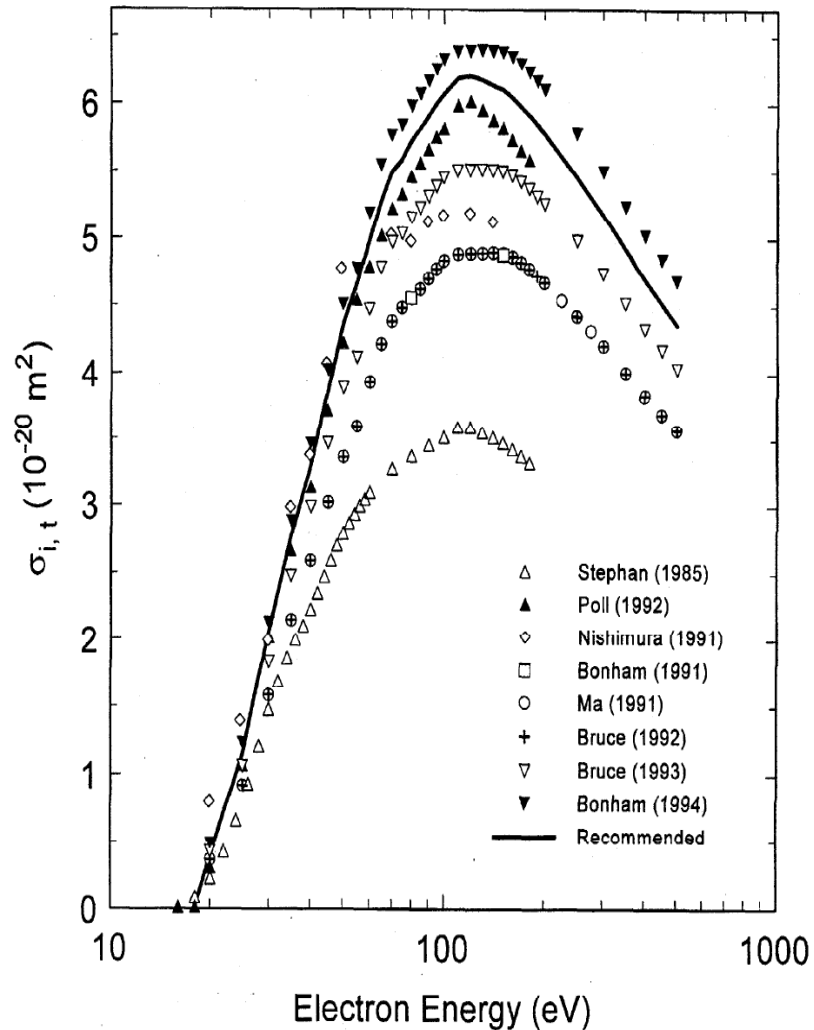

FIG. 17. Total ionization cross section  $\sigma_{i,t}(\epsilon)$  as a function of electron energy for CF<sub>4</sub>. Measured values:  $\Delta$ , Ref. 43;  $\blacktriangle$ , Ref. 103;  $\square$ , Ref. 69;  $\circ$ , Ref. 98;  $+$ , Ref. 100;  $\nabla$ , Ref. 104;  $\blacktriangledown$ , data of Ref. 104 multiplied by 1.16 (per Bonham in Ref. 73);  $\diamond$ , Ref. 106. Recommended: —, average of  $\blacktriangle$  and  $\blacktriangledown$  (see Sec. 4.1 and Table 12).

# Ionization cross section, Different channels have different cross sections and dependencies on energy

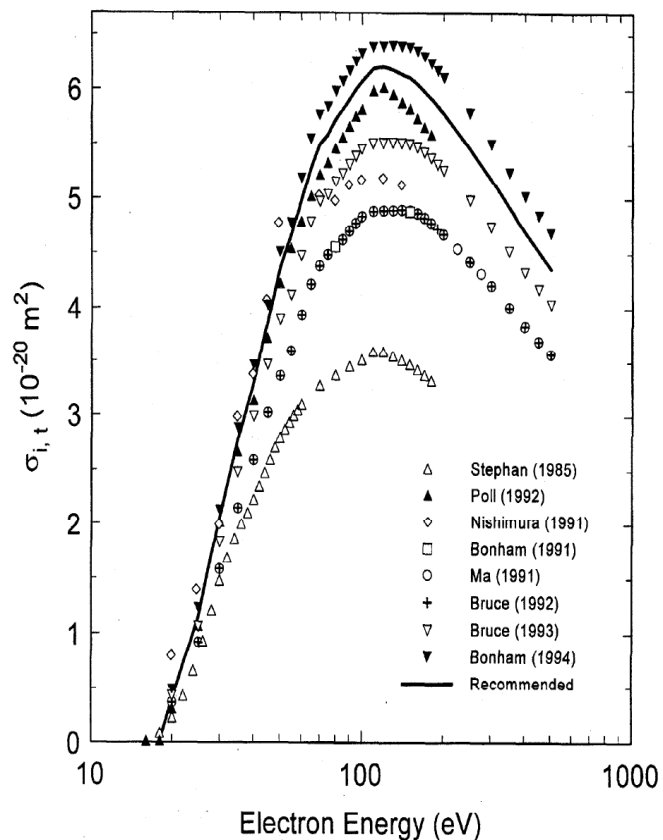

FIG. 17. Total ionization cross section  $\sigma_{i,t}(\epsilon)$  as a function of electron energy for  $\text{CF}_4$ . Measured values:  $\Delta$ , Ref. 43;  $\blacktriangle$ , Ref. 103;  $\square$ , Ref. 69;  $\circ$ , Ref. 98;  $+$ , Ref. 100;  $\nabla$ , Ref. 104;  $\blacktriangledown$ , data of Ref. 104 multiplied by 1.16 (per Bonham in Ref. 73);  $\diamond$ , Ref. 106. Recommended: —, average of  $\blacktriangle$  and  $\blacktriangledown$  (see Sec. 4.1 and Table 12).

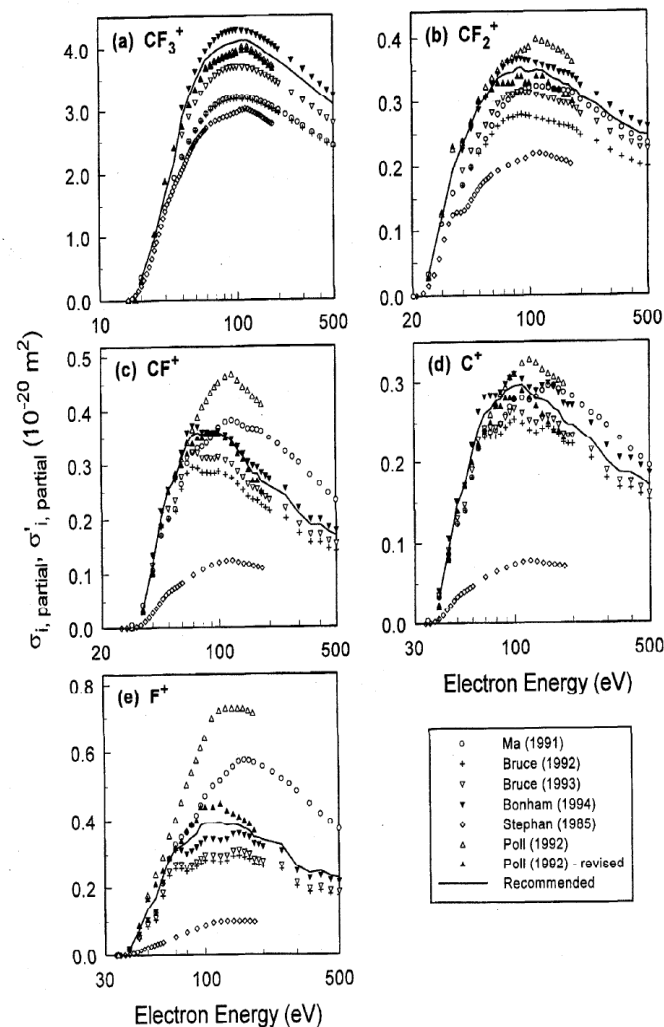

FIG. 19. Partial ionization cross section for the production of (a)  $\text{CF}_3^+$ , (b)  $\text{CF}_2^+$ , (c)  $\text{CF}^+$ , (d)  $\text{C}^+$ , and (e)  $\text{F}^+$  by electron collision on  $\text{CF}_2$ .  $\sigma_{i,\text{partial}}(\epsilon)$ :  $\diamond$ , Ref. 43;  $\Delta$ , Ref. 103;  $\circ$ , Ref. 98.  $\sigma_{i,\text{partial}}(\epsilon)$ :  $+$ , Ref. 100;  $\nabla$ , Ref. 104;  $\blacktriangledown$ , Ref. 73;  $\blacktriangle$ , revised data of Ref. 103 (see text). —, average of  $\blacktriangledown$  and  $\blacktriangle$  (see Sec. 4.2 and Table 15).

## Electron Interactions with $\text{CF}_4$

L. G. Christophorou,<sup>a)</sup> J. K. Olthoff, and M. V. S. Rao

*National Institute of Standards and Technology, Gaithersburg, Maryland 20899-0001*

# Thomson's formula

$$\sigma_j = C_j (\epsilon - E_{ION})$$

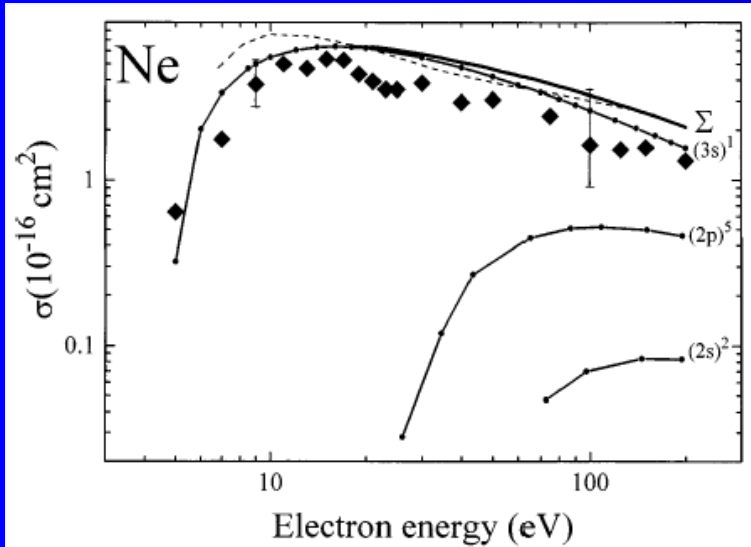
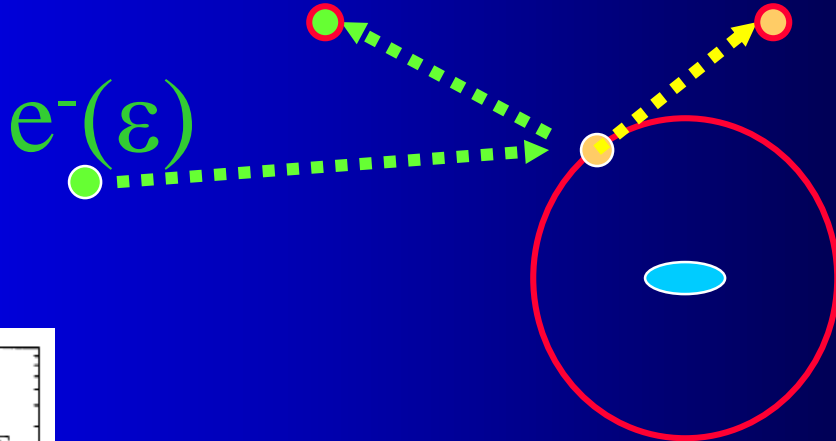
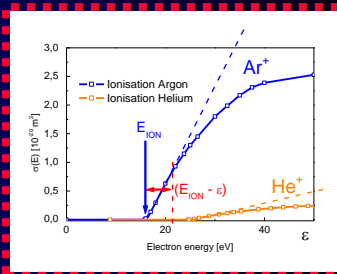
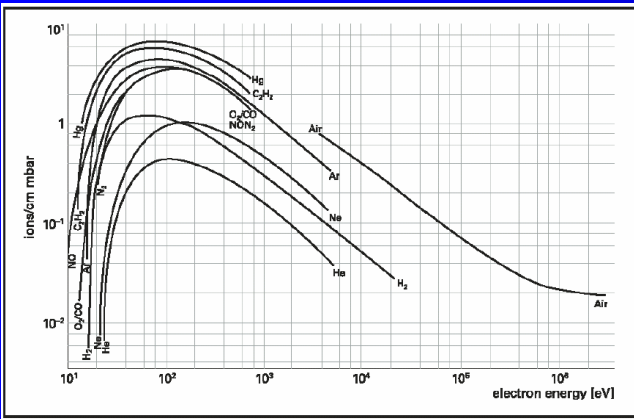

Ionization if  $\Delta\epsilon > I$   
 Formula of Rutherford for coulomb force  
 $d\sigma = e^4 d\Theta / 4\epsilon^2 \sin^4(\phi/2) \dots \sigma_i = \pi e^4 / I \cdot (\epsilon - I) / \epsilon^3$   

$$\sigma_i = 4\pi a_0^2 (I_H / \epsilon)^2 \cdot (\epsilon - I) / I$$
  

$$\rightarrow \sigma_i = 4\pi a_0^2 (I_H / \epsilon)^2 \cdot (\epsilon / I - 1) = f_{\text{function}}(\epsilon / I)$$

$$\sigma_i = \sum \sigma_{in} \quad \text{sum of the various subshell contributions}$$

Calculated ionization cross section of the  $^3P_0$  state in Ne using the DM formalism. The full curves refer to the contributions from the various subshells and have been labeled appropriately. The sum of the various subshell contributions has been labeled by the symbol  $\Sigma$ . Also shown is the Born calculation of Ton-That and Flannery (broken curve, see text for details). The experimental data points (diamonds) are those of Johnston *et al*. Two typical error bars (combined systematic and statistical uncertainty) are shown for the experimental data.

# Near the threshold → linear approximation

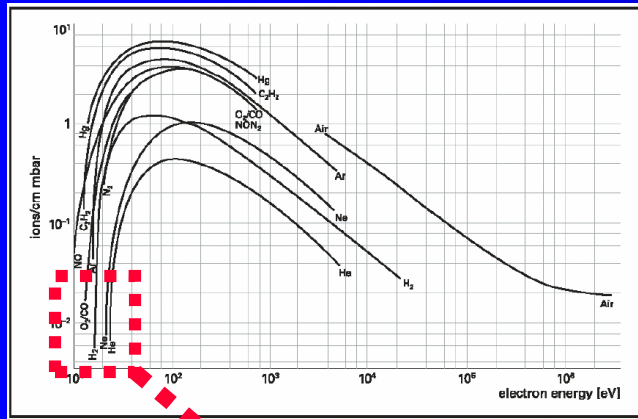

$$\sigma_i = 4\pi a_0^2 (I_H / \varepsilon)^2 \cdot (\varepsilon - I) / I$$

$$\rightarrow \sigma_i = 4\pi a_0^2 (I_H / \varepsilon)^2 \cdot (\varepsilon / I - 1) = f_{\text{function}}(\varepsilon / I)$$

$$\sigma_j = C_j (\varepsilon - E_{\text{ION}})$$

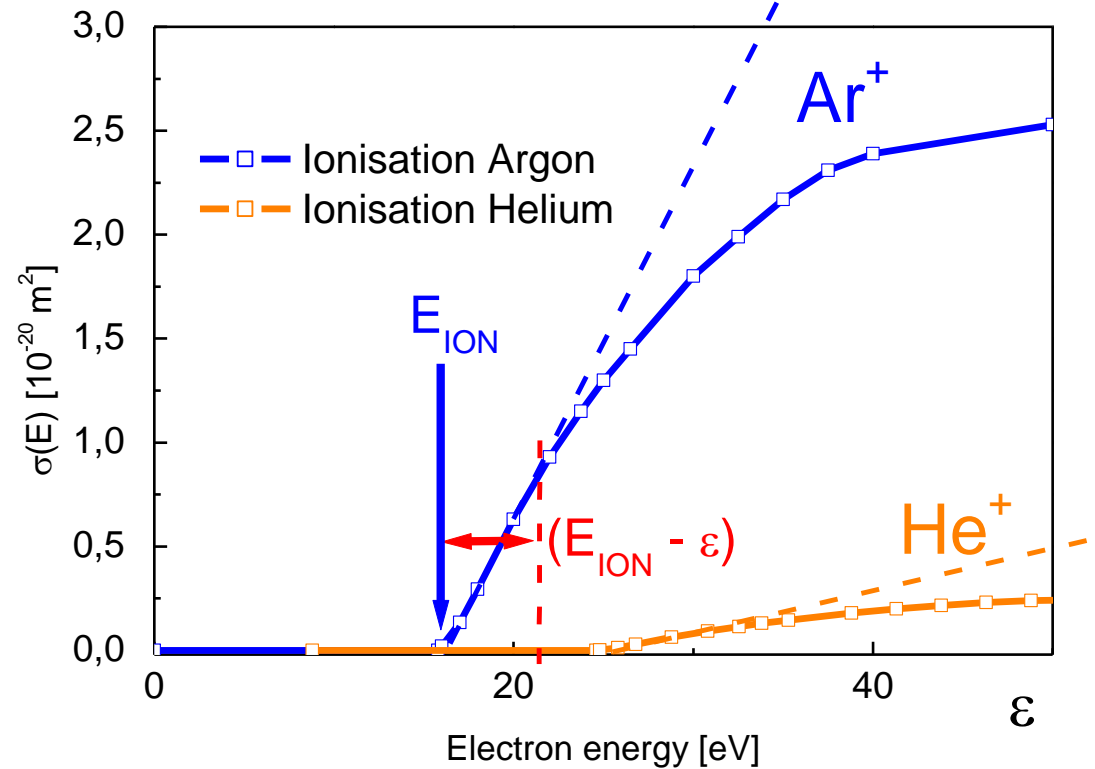



# Ionization cross section recent studies Ar - higher approximation

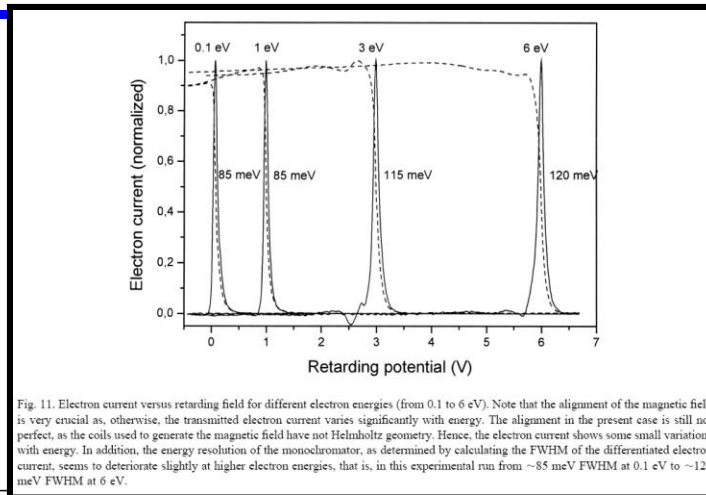
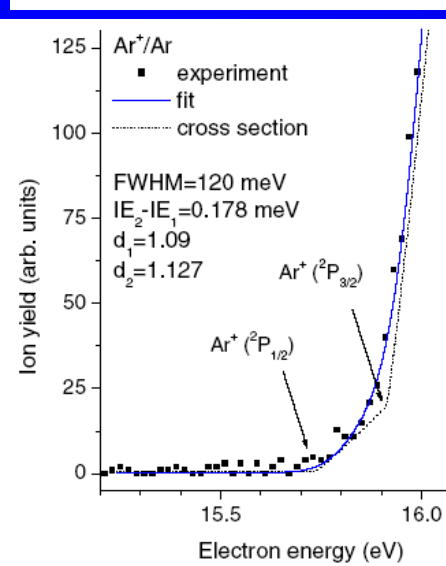

Fig. 11. Electron current versus retarding field for different electron energies (from 0.1 to 6 eV). Note that the alignment of the magnetic field is very crucial as, otherwise, the transmitted electron current varies significantly with energy. The alignment in the present case is still not perfect, as the coils used to generate the magnetic field have not Helmholtz geometry. Hence, the electron current shows some small variations with energy. In addition, the energy resolution of the monochromator, as determined by calculating the FWHM of the differentiated electron current, seems to deteriorate slightly at higher electron energies, that is, in this experimental run from ~85 meV FWHM at 0.1 eV to ~120 meV FWHM at 6 eV.

**IE – ionization energy**  
**EII – electron Impact Ionization**

**IE of Ar is 15.759+-0.001eV**

**IE<sub>1</sub> of Ar<sup>+</sup>(<sup>2</sup>P<sub>1/2</sub>)**

**IE<sub>2</sub> of Ar<sup>+</sup>(<sup>2</sup>P<sub>3/2</sub>)**

**IE<sub>2</sub> - IE<sub>1</sub> = 0.178eV**

**Figure 2.** The ion yield curve Ar<sup>+</sup>/Ar as measured in the present experiment. The full curve is the result of the fitting procedure, involving a convolution of the cross section (dotted curve; the arrows indicating the thresholds for the two spin states) and an electron energy distribution function with a width of 120 meV FWHM (for details see text).

The measured Ar<sup>+</sup> ion yield is fitted with a function  $I(U, \mathbf{p}, s)$ :

$$I(U, \mathbf{p}, s) = \sigma_w(E, \mathbf{p}) \cdot f(E, U) dE + s \quad (6)$$

where  $s$  is the background signal below the ionization threshold and the cross section  $\sigma_w$  for EII at the ionization threshold of Ar is assumed to have the form:

$$\begin{aligned} \sigma_w(E, \mathbf{p}) = & 0 && \text{for } E < IE_1(\text{Ar}) \\ & A_1(E - IE_1)^{d_1} && \text{for } E > IE_1 \text{ and } E < IE_2 \\ & A_1(E - IE_1)^{d_1} + A_2(E - IE_2)^{d_2} && \text{for } E > IE_2 \end{aligned}$$

# Ionization cross sections H<sub>2</sub> – details near the threshold

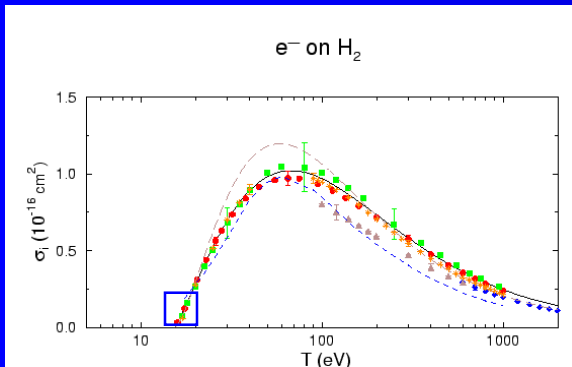

**TABLE 13.6**  
*Comparison of observed and calculated energy separation of various vibrational levels of H<sub>2</sub><sup>+</sup>*

	Energy separations (eV)					
Vibnl. levels	0-1	1-2	2-3	3-4	4-5	5-6
Calculated	0.269	0.254	0.238	0.223	0.208	0.192
Observed	0.272	0.263	0.233	0.237	0.21	0.20

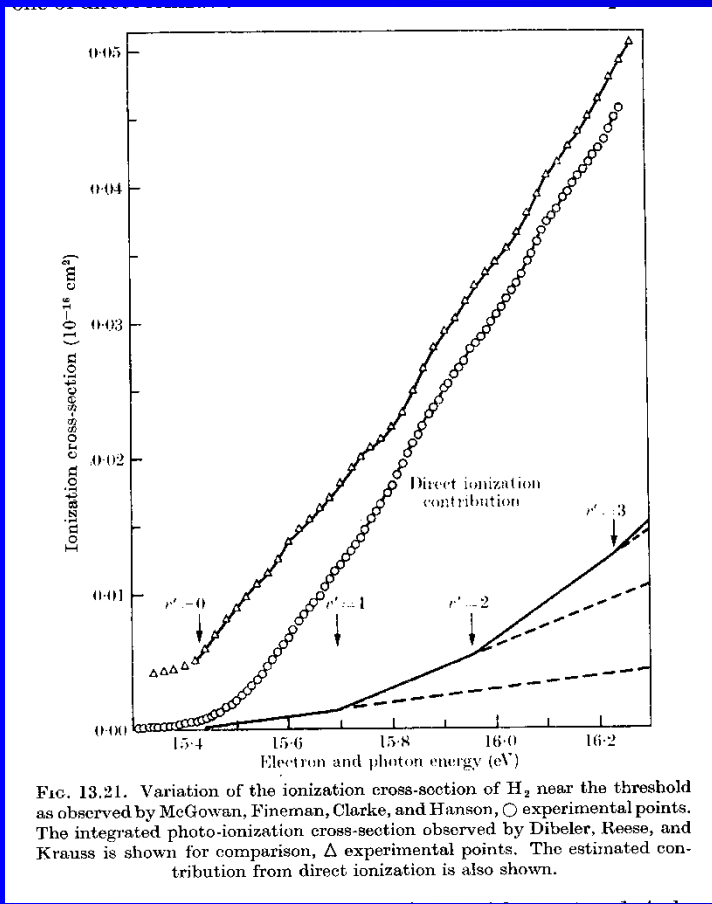

FIG. 13.21. Variation of the ionization cross-section of H<sub>2</sub> near the threshold as observed by McGowan, Fineman, Clarke, and Hanson, ○ experimental points. The integrated photo-ionization cross-section observed by Dibeler, Reese, and Krauss is shown for comparison, Δ experimental points. The estimated contribution from direct ionization is also shown.

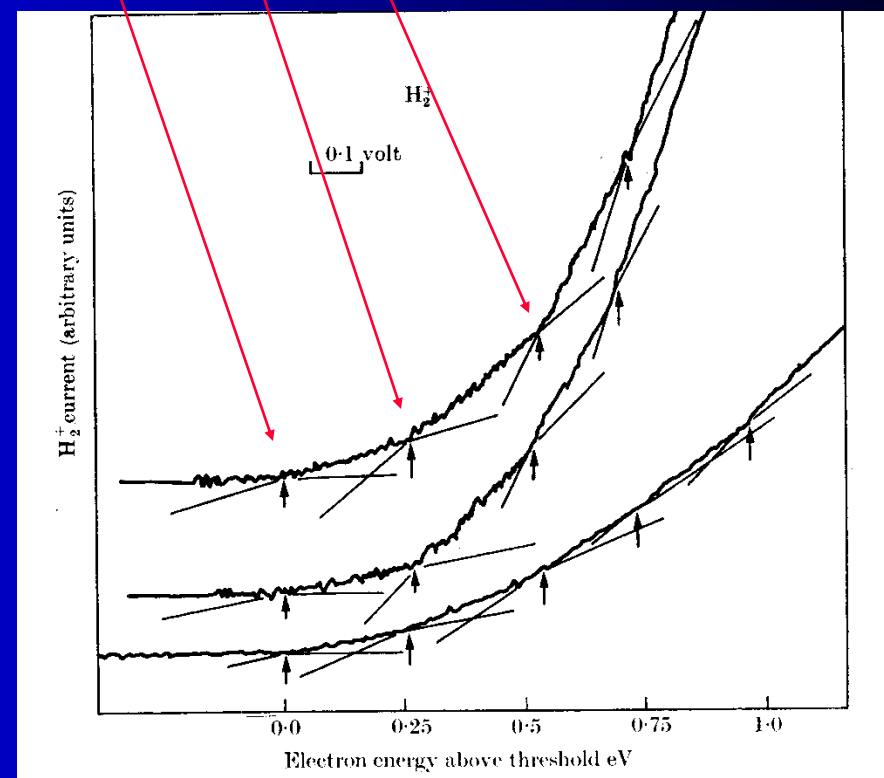
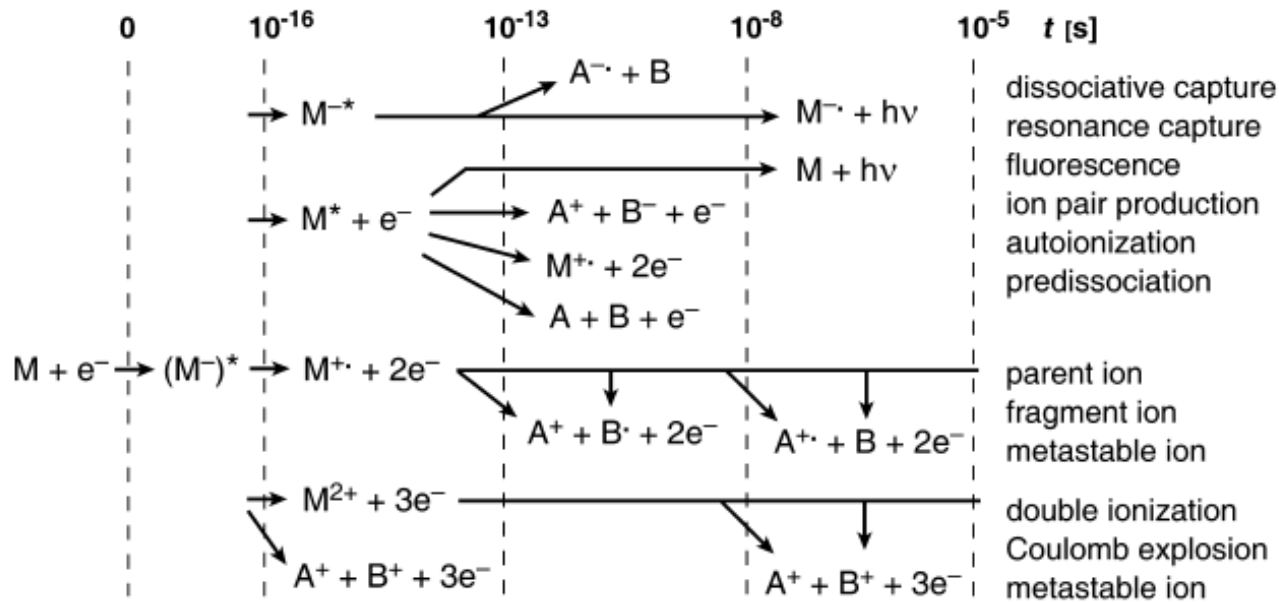
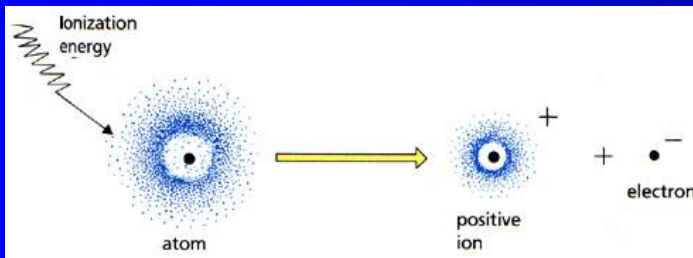

FIG. 13.19. Variation of the ionization cross-section of H<sub>2</sub> near the threshold as observed by Marnet and Kerwin.



**Fig. 2.10.** Schematic time chart of possible electron ionization processes. Adapted from Ref. [39] with permission. © Wiley & Sons, 1986.



Potential Energy diagram for diatomic molecule.

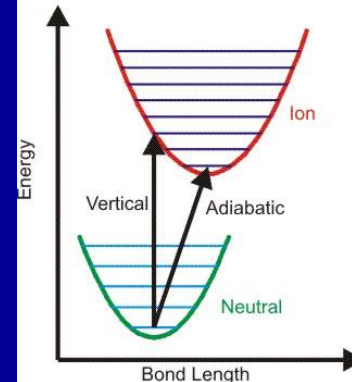

# Ionization cross section $N_2$

BEB

W. Hwang, Y.-K. Kim and M.E. Rudd, J. Chem. Phys. **104**, 2956 (1996).

$e^-$  on  $N_2$

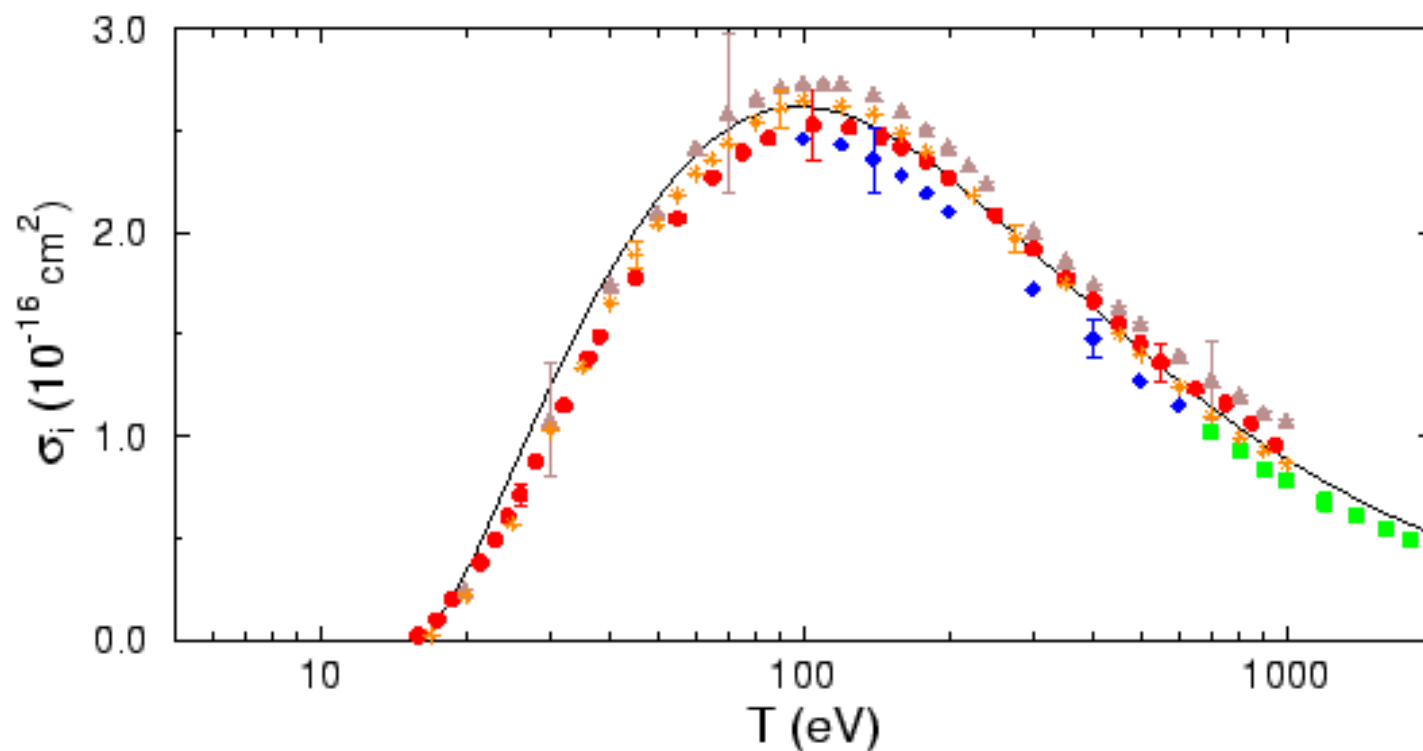

# Ionization cross section -acetylene $C_2H_2$

## Product channels

### Pragmatic approach

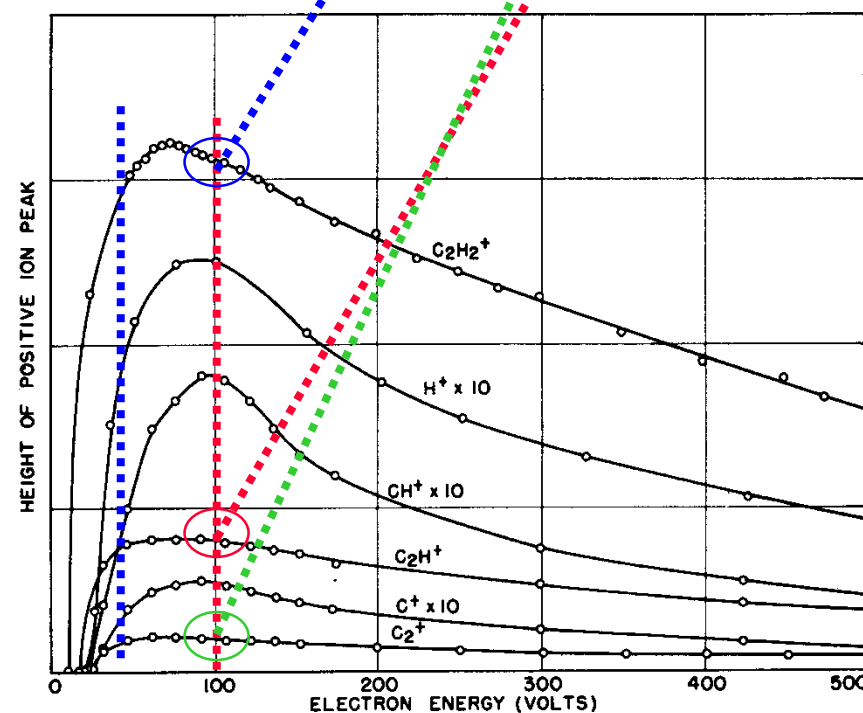
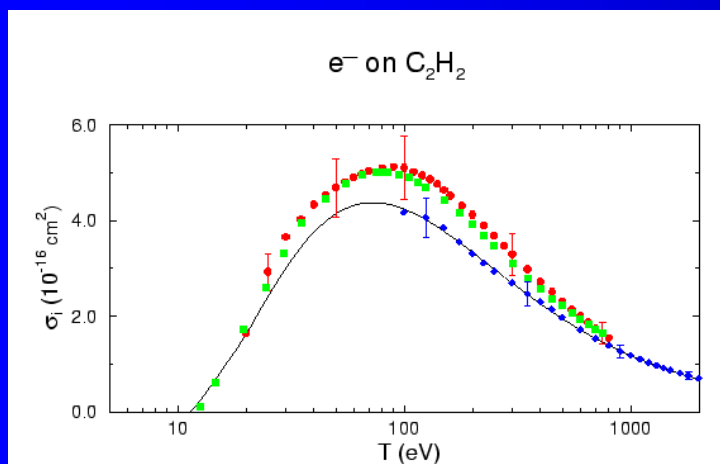
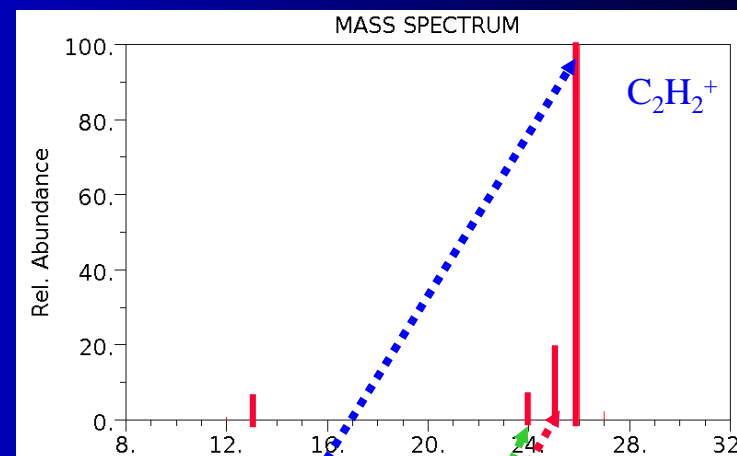
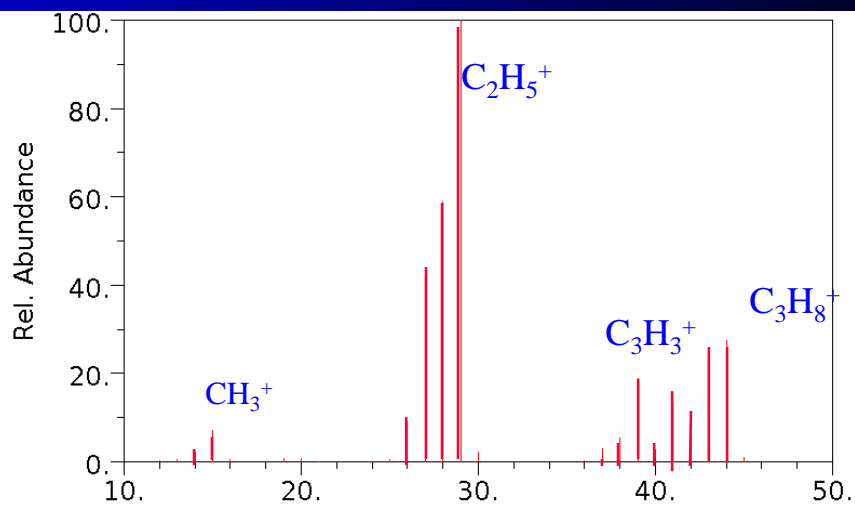
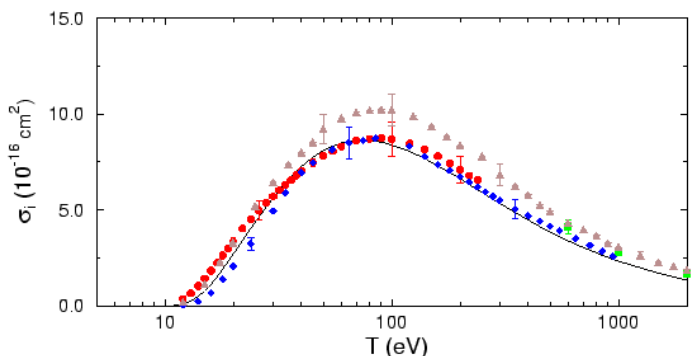

FIG. 6. Ionization efficiency curves for several ions from acetylene (493).

# Ionization cross section data from <http://webbook.nist.gov>

$e^-$  on  $C_3H_8$



$e^-$  on  $C_2H_6$

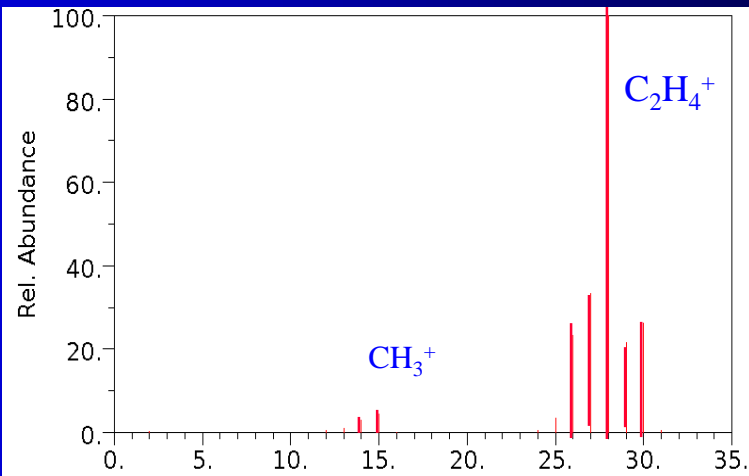
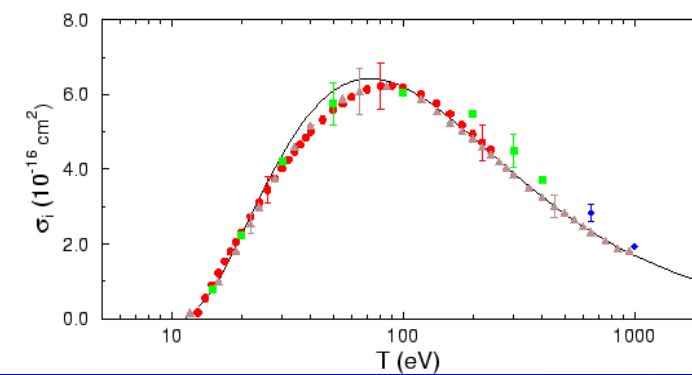

How to recognize spectra ???

# Ionization - EII of CH<sub>4</sub>

Determination of ionization energies (IEs)

for EII of CH<sub>4</sub> for the following reactions:

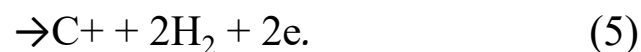
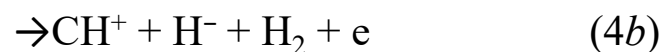
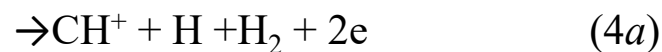
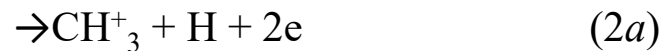

$$\sigma w(E, \rho) = 0$$

$$A_1(E - \text{IE}_1)^{d1}$$

for  $E < \text{IE}_1(\text{Ar})$

for  $E > \text{IE}_1$  and  $E < \text{IE}_2$

$$A_1(E - \text{IE}_1)^{d1} + A_2(E - \text{IE}_2)^{d2}$$

for  $E > \text{IE}_2$

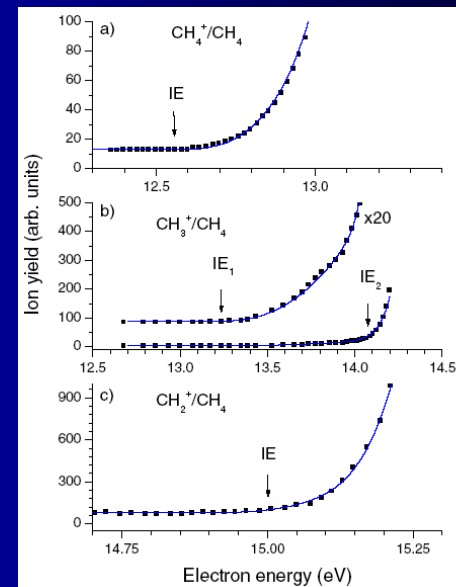

Figure A.1. Ion yield curve for  $\text{CH}_4^+$ ,  $\text{CH}_3^+$  and  $\text{CH}_2^+$ / $\text{CH}_4$  obtained through digitalization of the data from [3]. Full curves present fits through these data. Arrows indicate the estimated IEs derived by the fitting procedure.

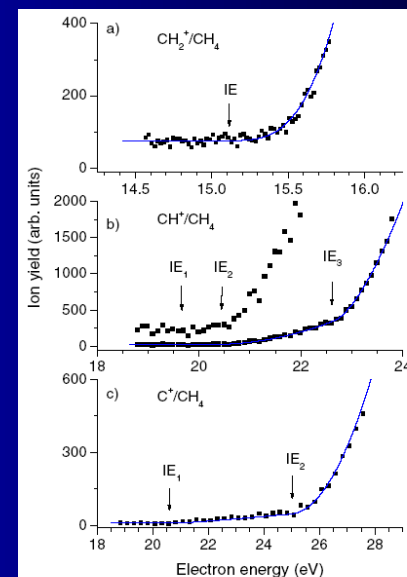
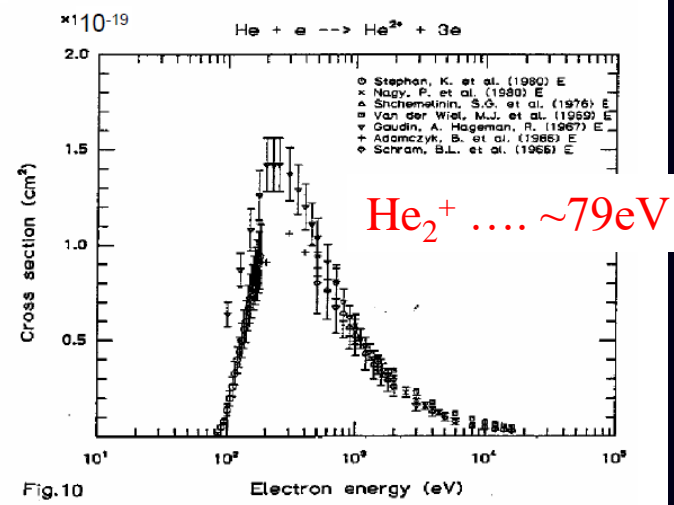
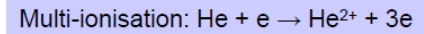
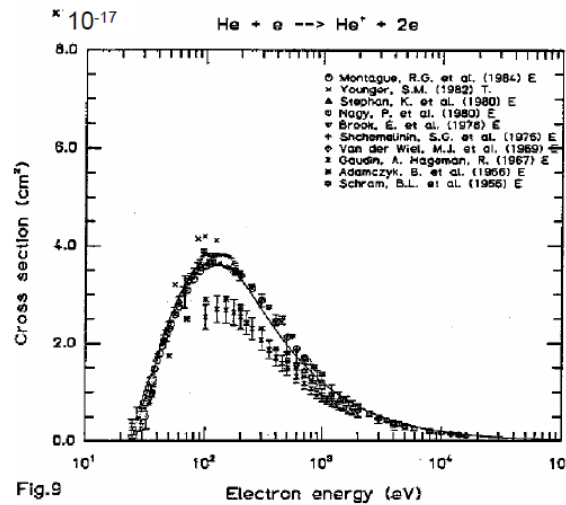
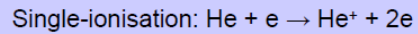

Figure 5. Ion yield curve for  $\text{CH}_2^+$ ,  $\text{CH}^+$  and  $\text{C}^+$ / $\text{CH}_4$  as measured at 293 K. Full curves present fits through the experimental data. Arrows indicate the IEs derived by the fitting procedure. Note that for the case of  $\text{CH}^+$  only  $\text{IE}_2$  and  $\text{IE}_3$  have been derived from the present data;  $\text{IE}_1$  has been calculated from the known EA of H (see text).



# Ionization of He



## Ionization of the excited state

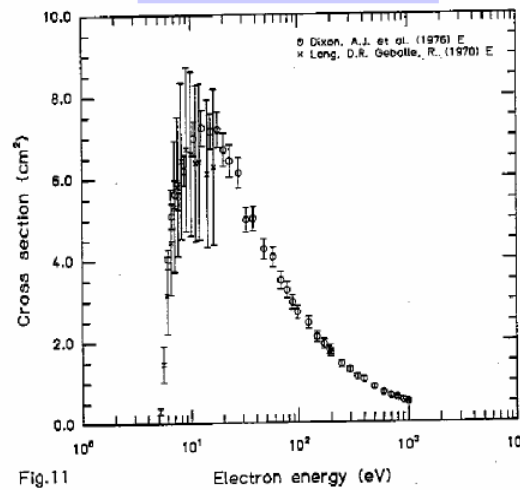
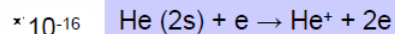

## Ionization of singly charged He

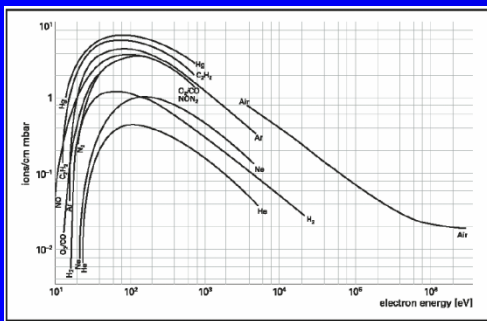
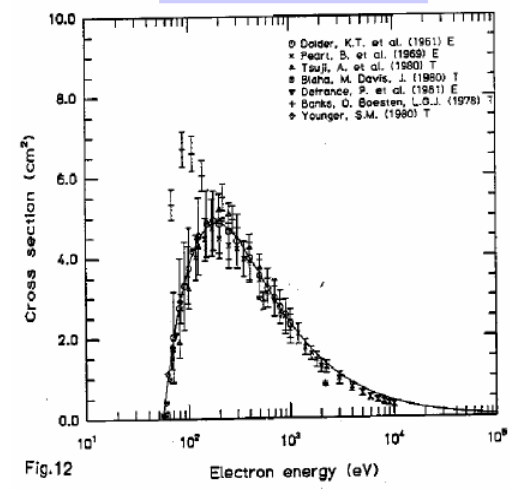
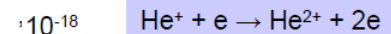

# Multiple ionization

## Multiple ionization of helium and krypton by electron impact close to threshold: appearance energies and Wannier exponents

J. Phys. B: At. Mol. Opt. Phys. **35** (2002) 4685–4694

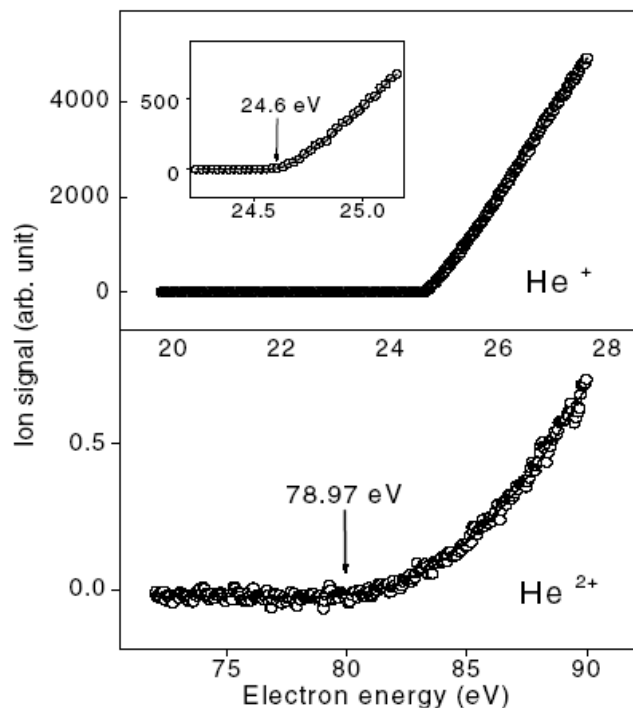

**Figure 1.** Ion signal as a function of electron energy for the formation of He<sup>+</sup> ions (top) and He<sup>2+</sup> ions (bottom) in the near-threshold region. The measured data are shown as open circles, the fits are shown as solid curves. The AEs, which are indicated, are the AEs for the individual data sets shown and may differ from the AE values listed in table 1 which were obtained from a comprehensive analysis of many individual data sets.

**Table 1.** AE values in eV for the formation of He<sup>+</sup> and He<sup>2+</sup> ions in comparison with other measured or calculated AE values.

	Spectroscopic value [1]	Redhead [45]	This work
He <sup>+</sup>	24.59	—	24.6 ± 0.15
He <sup>2+</sup>	79.00	77.58	79.05 ± 0.3

He<sup>2+</sup> .... ~79eV

# Multiple ionization

Multiple ionization of helium and krypton by electron impact close to threshold: appearance energies and Wannier exponents

J. Phys. B: At. Mol. Opt. Phys. **35** (2002) 4685–4694

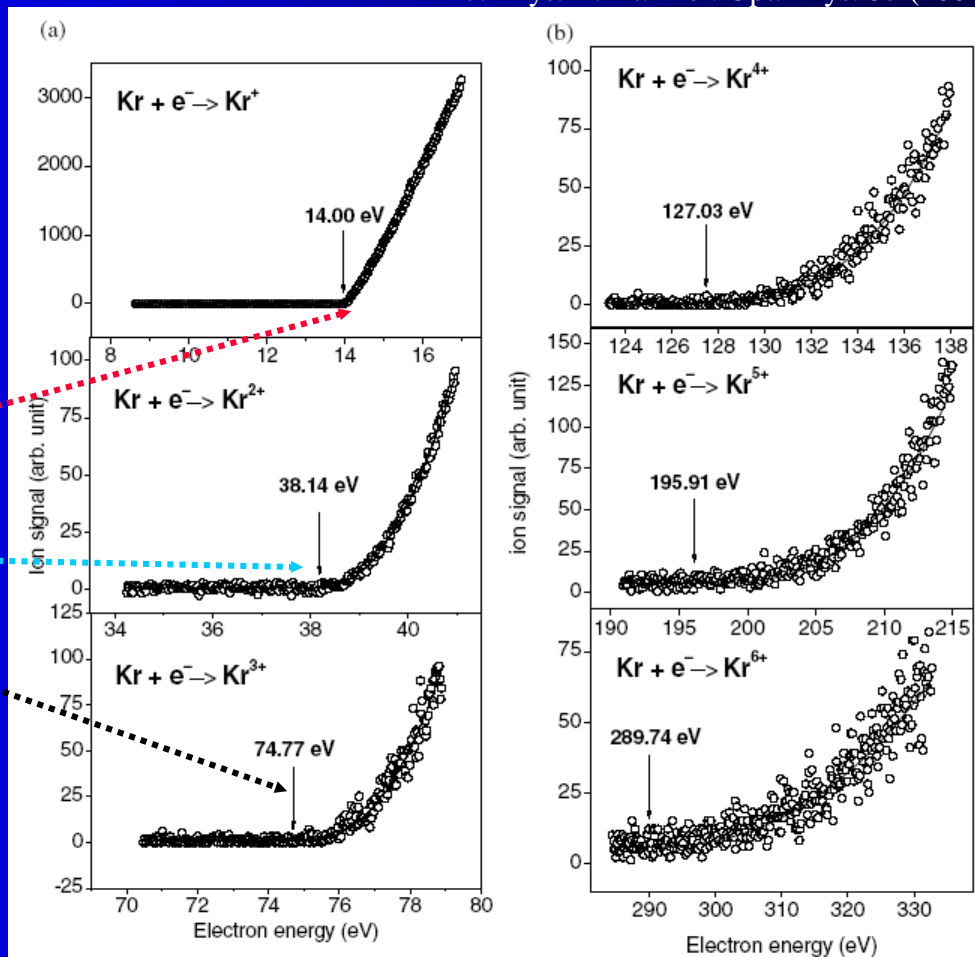
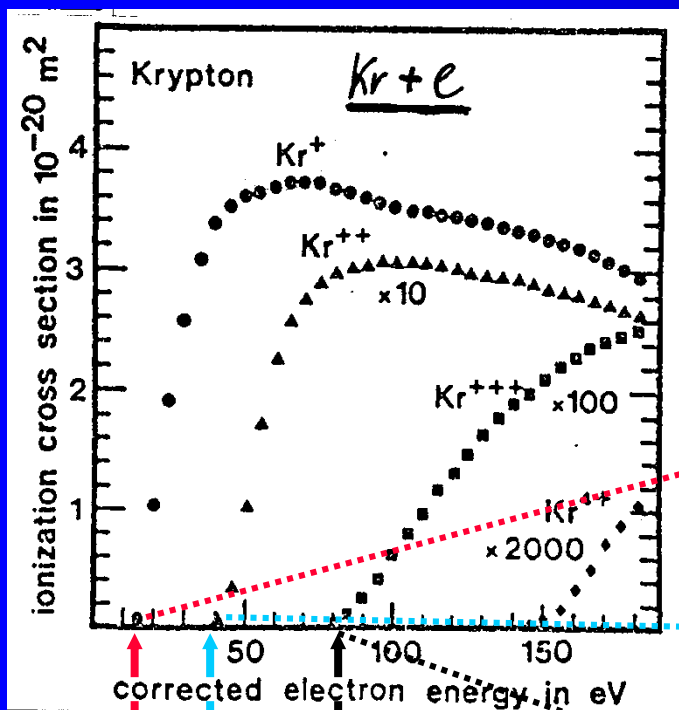
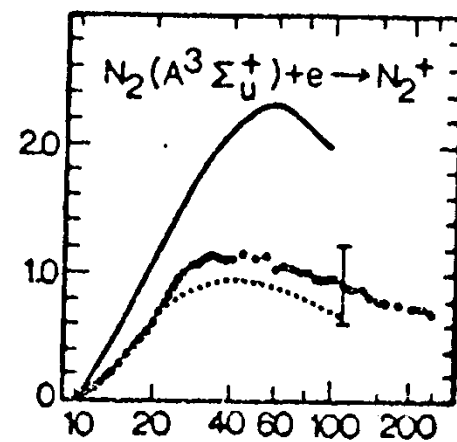
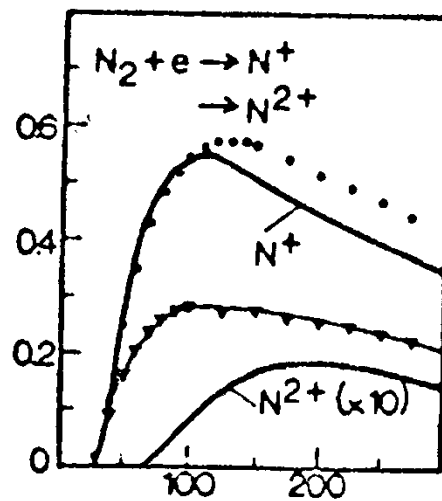
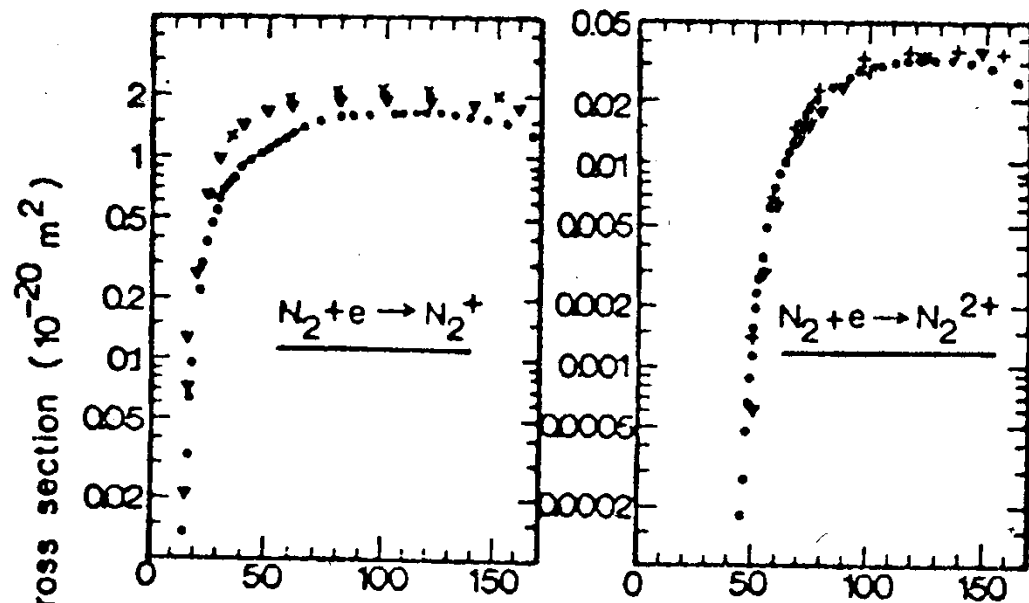
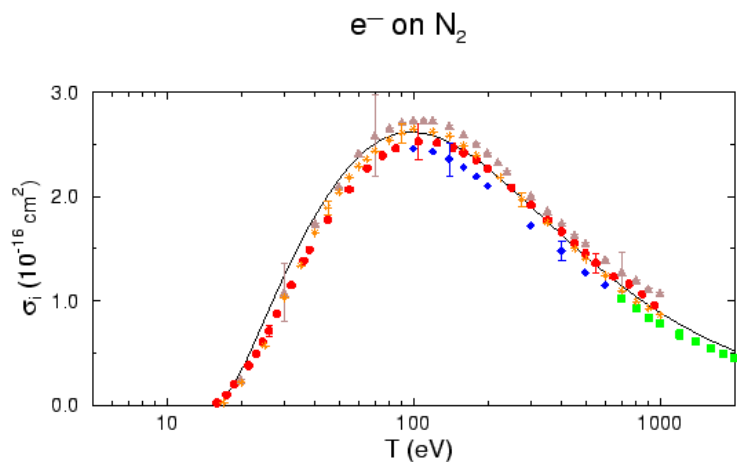

Figure 2. Ion signal as a function of electron energy for the formation of  $\text{Kr}^{n+}$  ions ( $n = 1-6$ ) in the near-threshold region. The measured data are shown as open circles, the fits are shown as solid curves. The AEs, which are indicated, are the AEs for the individual data sets shown and may differ from the AE values listed in table 2 which were obtained from a comprehensive analysis of many individual data sets.

# Multiple ionization



Electron energy (eV)

# Ionization of clusters



$$\sigma_{\text{average total}} = Z \cdot \sigma_{\text{effective}}$$

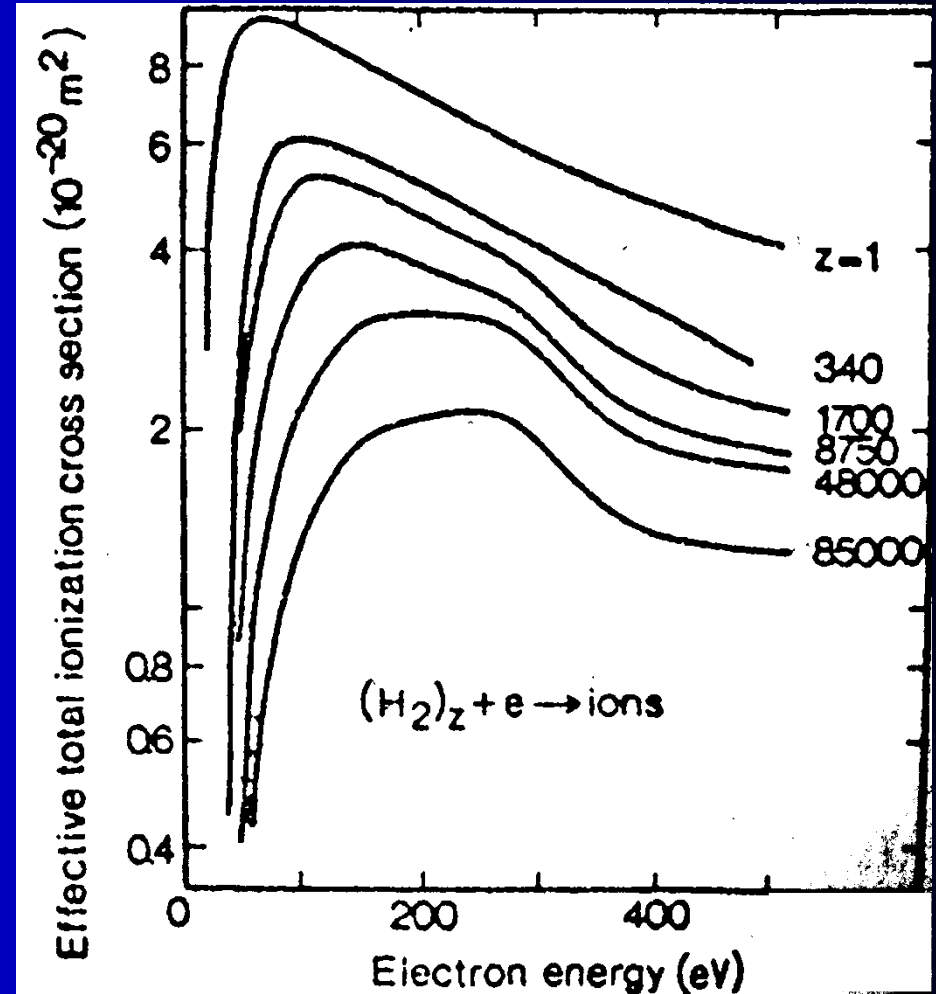

# Ionization of C60 Fulleren

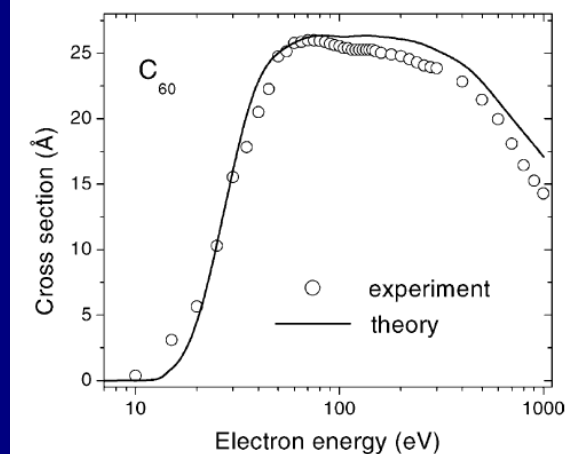
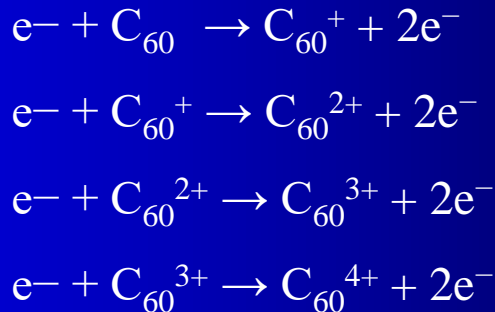
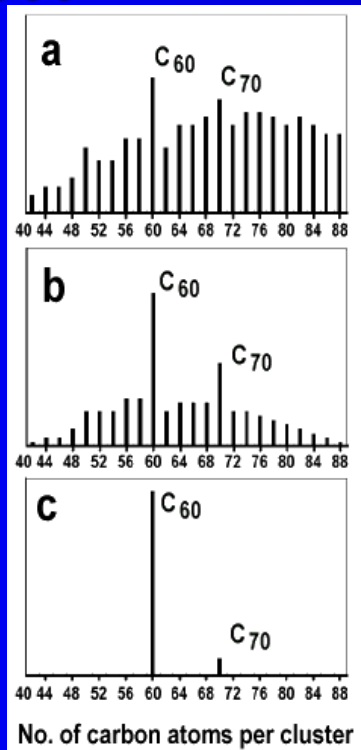
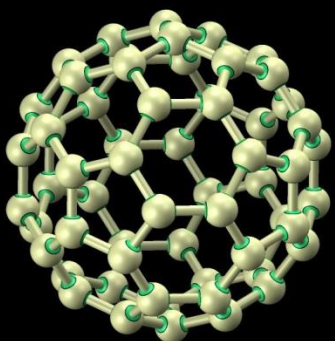

Fig. 6. Cross-section for the formation of  $C_{60}^+$  ions following electron-impact single ionization of  $C_{60}$ . The experimental data ( $\circ$ ) are from Ref. [18], the solid line represents the present calculation.

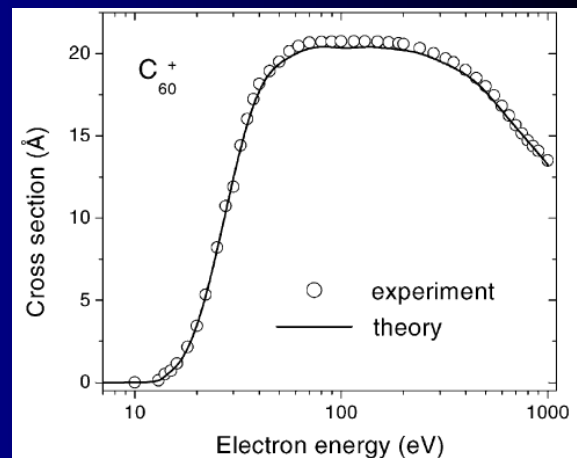
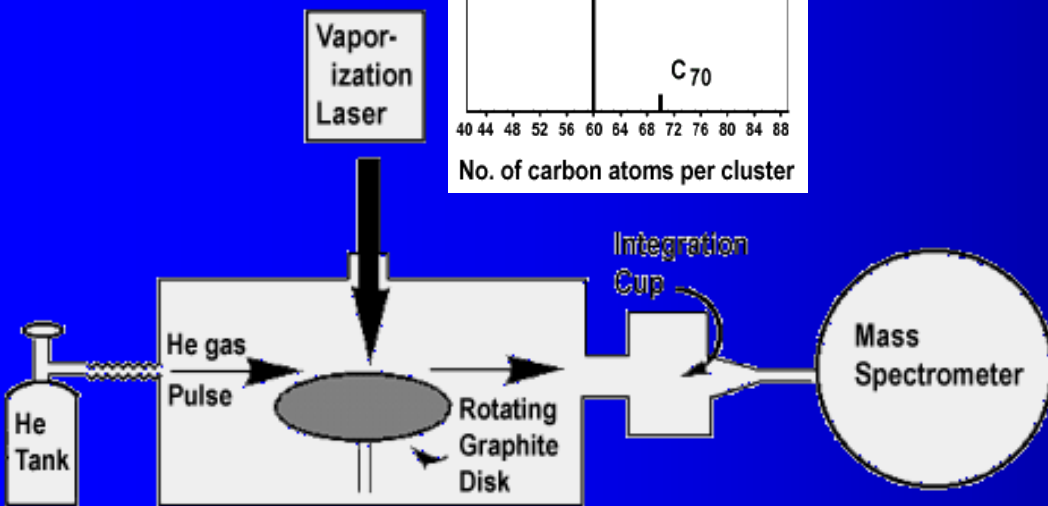

Fig. 3. Cross-section for the formation of  $C_{60}^{2+}$  ions following electron-impact single ionization of  $C_{60}^+$ . The experimental data ( $\circ$ ) are from Ref. [23], the solid line represents the present calculation.



Distribution of carbon clusters produced under various experimental conditions.

a) Low helium density over graphite target at time of laser vaporization.

b) High helium density over graphite target at time of laser vaporization.

c) Same as b), but with addition of "integration cup" to increase time between vaporization and cluster analysis.

# Electron-Impact Induced Fragmentation of Fullerene Ions

The measurements were performed employing the electron-ion crossed-beam setup. A commercially available powder of fullerenes was evaporated with an electrically heated oven. The neutral vapor was introduced into a 10 GHz Electron Cyclotron Resonance Ion Source (ECRIS). The extracted ion beam was collimated to  $2 \times 2 \text{ mm}^2$  after mass to charge analysis and crossed with an intense electron beam. The energy of the electrons can be varied between 10 and 1000 eV. After the electron-ion interaction the fragment ions  $\text{C}_{58}^{q+}$  were separated from the incident ion beam of  $\text{C}_{60}^{q+}$  by a  $90^\circ$  magnet and detected by a single-particle detector. The flight time between the interaction of the  $\text{C}_{60}^{q+}$  ions and the analysis of the product ions is in the order of  $10 \mu\text{s}$ . The current of the parent ion beam was measured simultaneously in a Faraday cup.

## Binding energy value of about 11 eV

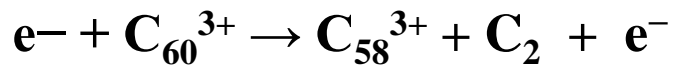

## IONIZATION

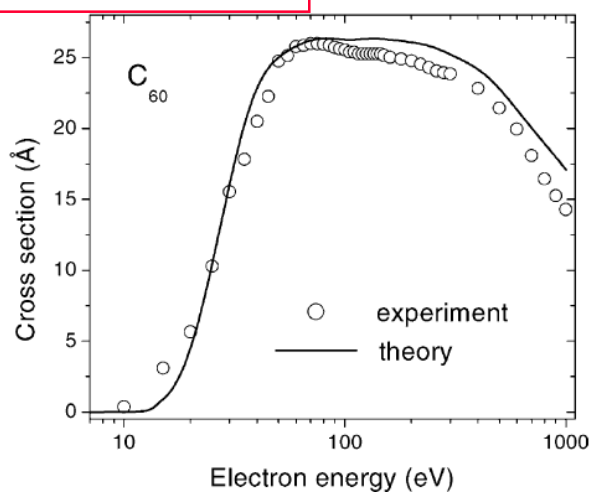

## FRAGMENTATION

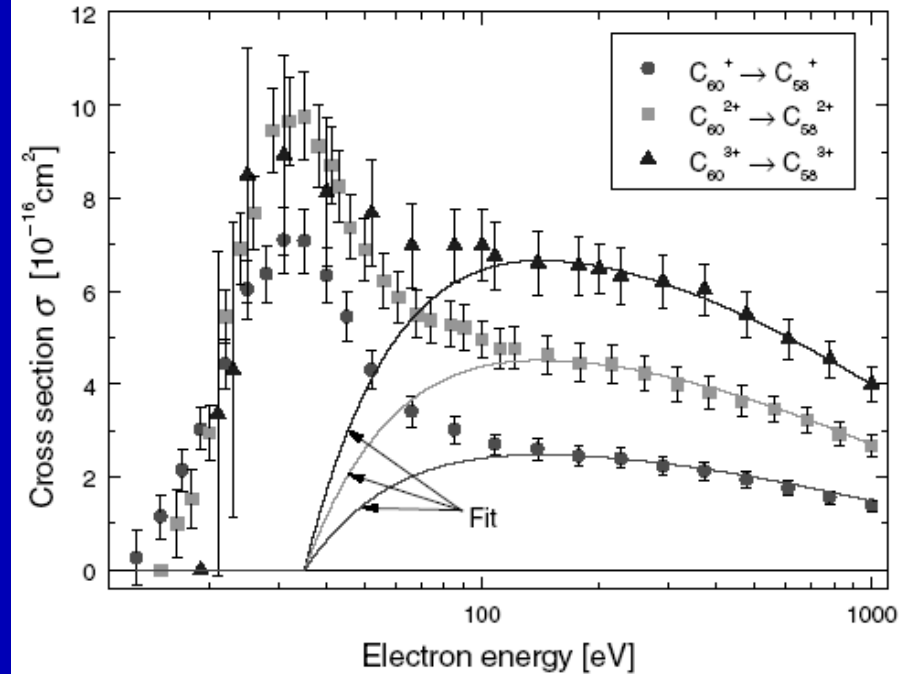

Absolute cross sections  $\sigma$  for the electron-impact induced  $\text{C}_2$  fragmentation of  $\text{C}_{60}^{q+}$  ions.



# Electron-Impact Induced Ionization of Fullerene Ions

## IONIZATION

A semi-empirical concept for the calculation of electron-impact ionization cross-sections of neutral and ionized fullerenes

International Journal of Mass Spectrometry 223–224 (2003) 1–8

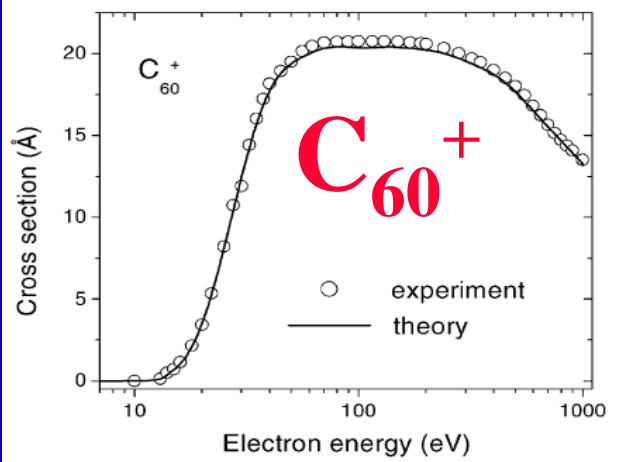
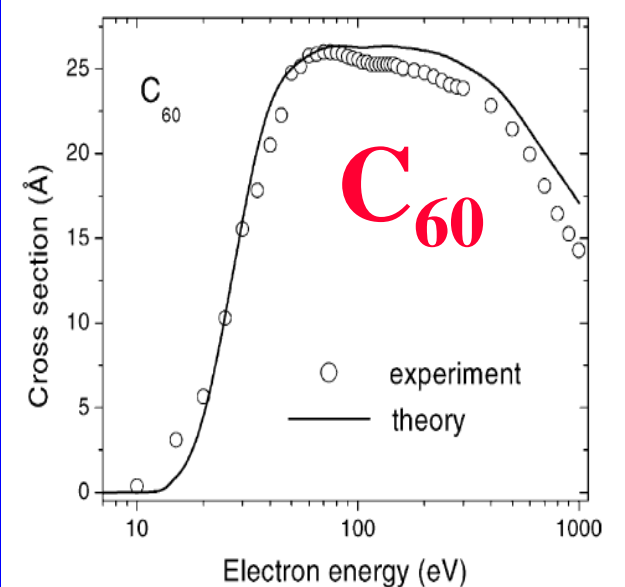

Fig. 3. Cross-section for the formation of  $C_{60}^{2+}$  ions following electron-impact single ionization of  $C_{60}^+$ . The experimental data (○) are from Ref. [23], the solid line represents the present calculation.

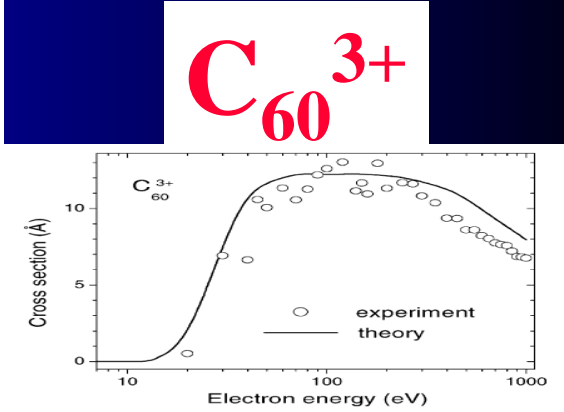
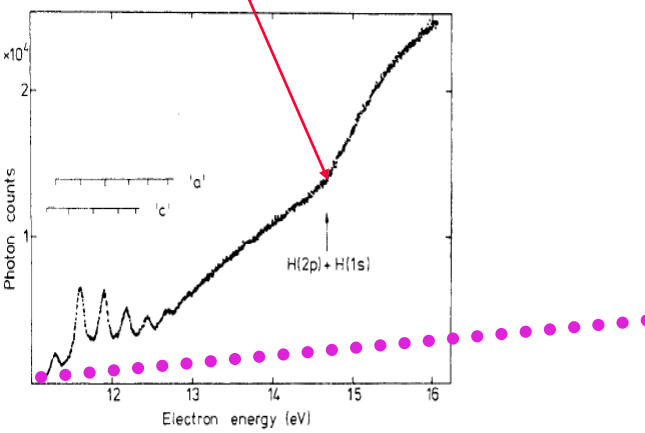
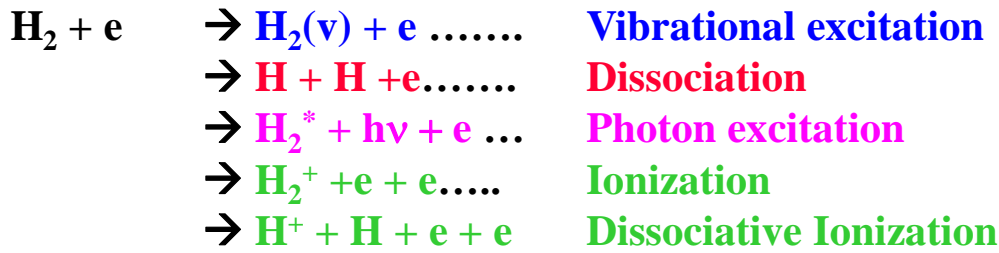
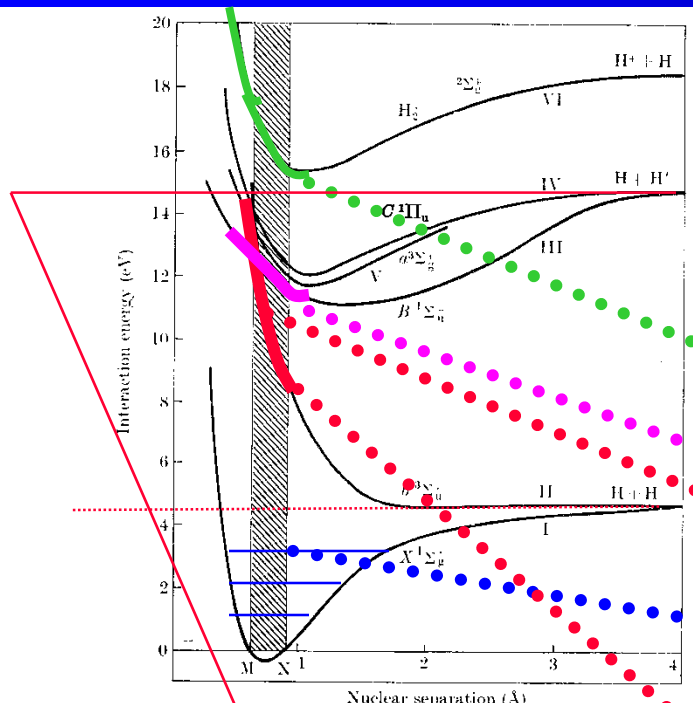
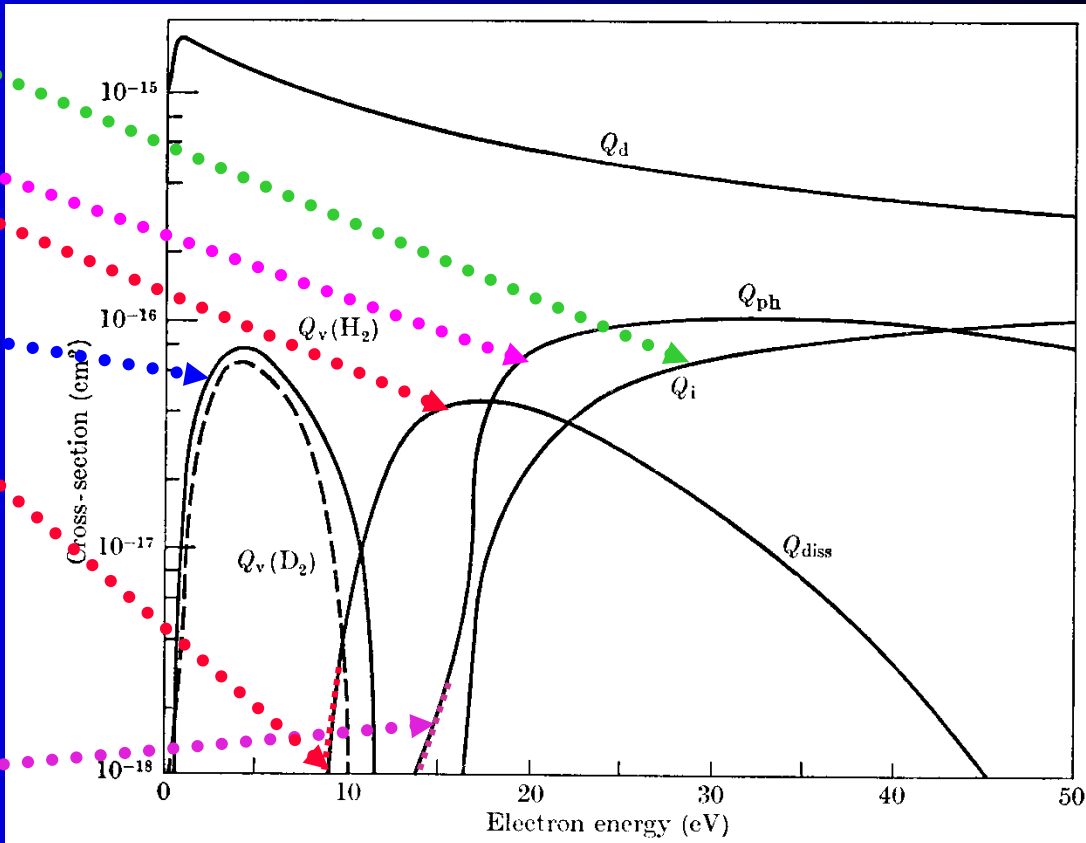

Fig. 4. Cross-section for the formation of  $C_{60}^{2+}$  ions following electron-impact single ionization of  $C_{60}^{3+}$ . The experimental data (○) are from Ref. [23], the solid line represents the present calculation.

# Cross sections for vibrational excitation, dissociation, ionization...H<sub>2</sub>



**Figure 3.** Optical excitation function for VUV photons measured with channeltron and MgF<sub>2</sub> window (1120–1300 Å); pressure 4 × 10<sup>-7</sup> bar; collection time 7 h; 4.9 meV/channel. Energy positions of known resonances are indicated. The dissociation energy for H(2p)+H(1s) is marked by an arrow.



**FIG. 13.37.** Cross-sections assumed by Engelhardt and Phelps in their analysis of swarm data in H<sub>2</sub> and D<sub>2</sub> for electrons of characteristic energy greater than 1 eV. Q<sub>d</sub> momentum-transfer cross-section, Q<sub>i</sub>, ionization cross-section, Q<sub>diss</sub> dissociation cross-section, Q<sub>ph</sub> photon excitation cross-section, Q<sub>v</sub> vibrational excitation cross-section (— H<sub>2</sub>, --- D<sub>2</sub>).

# Cross sections for ionization...H<sub>2</sub>

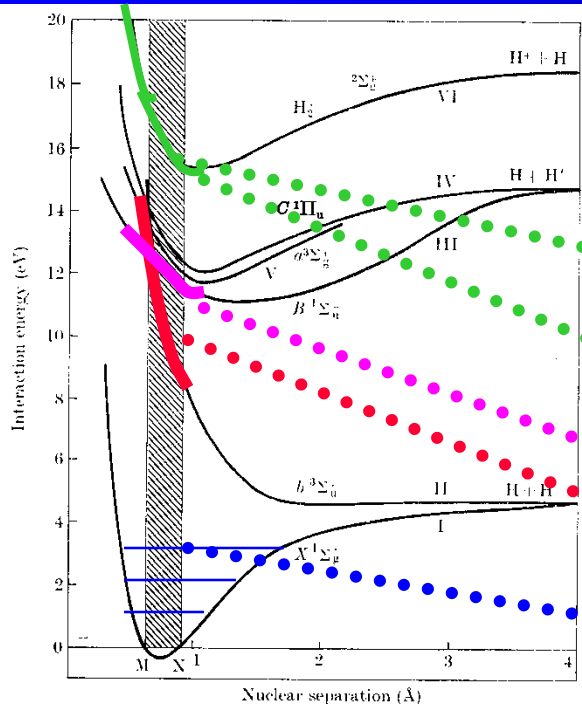

FIG. 13.1. Potential energy curves for electronic states of H<sub>2</sub> and H<sup>+</sup> + H, with  $20 \text{ V} < V < 200 \text{ V}$ .

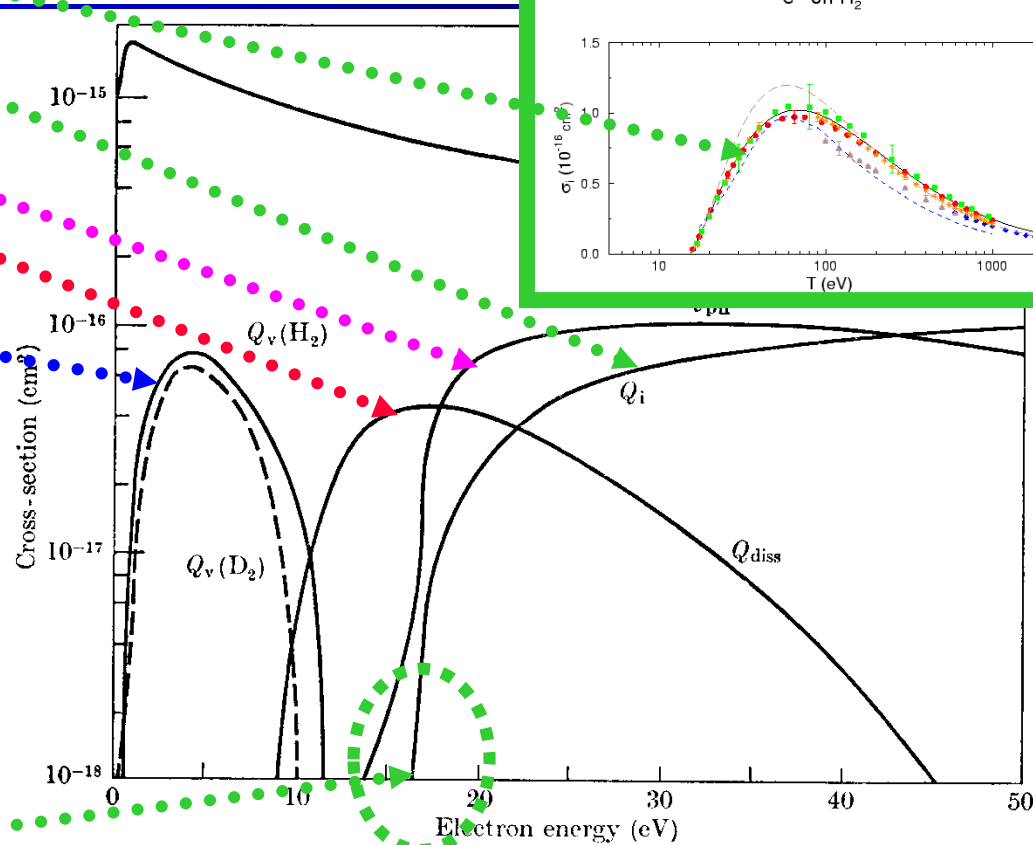
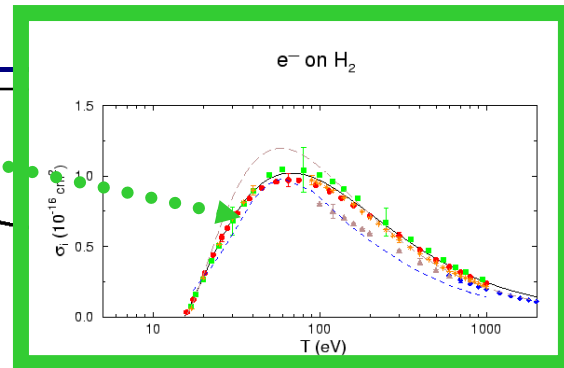
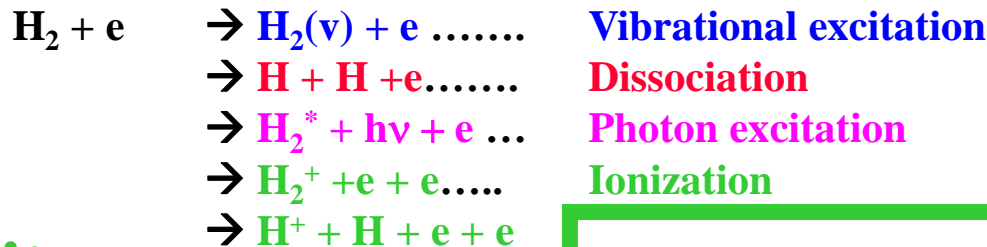

FIG. 13.37. Cross-sections assumed by Engelhardt and Phelps in their analysis of swarm data in H<sub>2</sub> and D<sub>2</sub> for electrons of characteristic energy greater than 1 eV.  $Q_d$  momentum-transfer cross-section,  $Q_i$  ionization cross-section,  $Q_{diss}$  dissociation cross-section,  $Q_{ph}$  photon excitation cross-section,  $Q_v$  vibrational excitation cross-section (— H<sub>2</sub>, ---- D<sub>2</sub>).

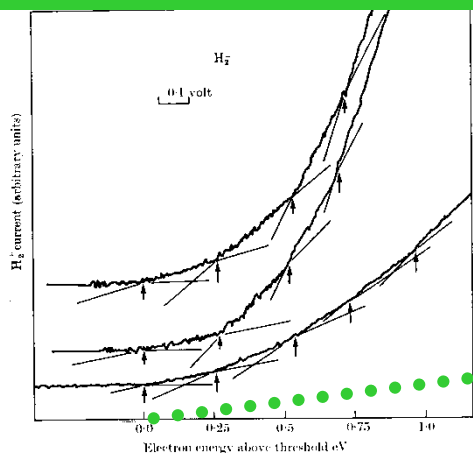
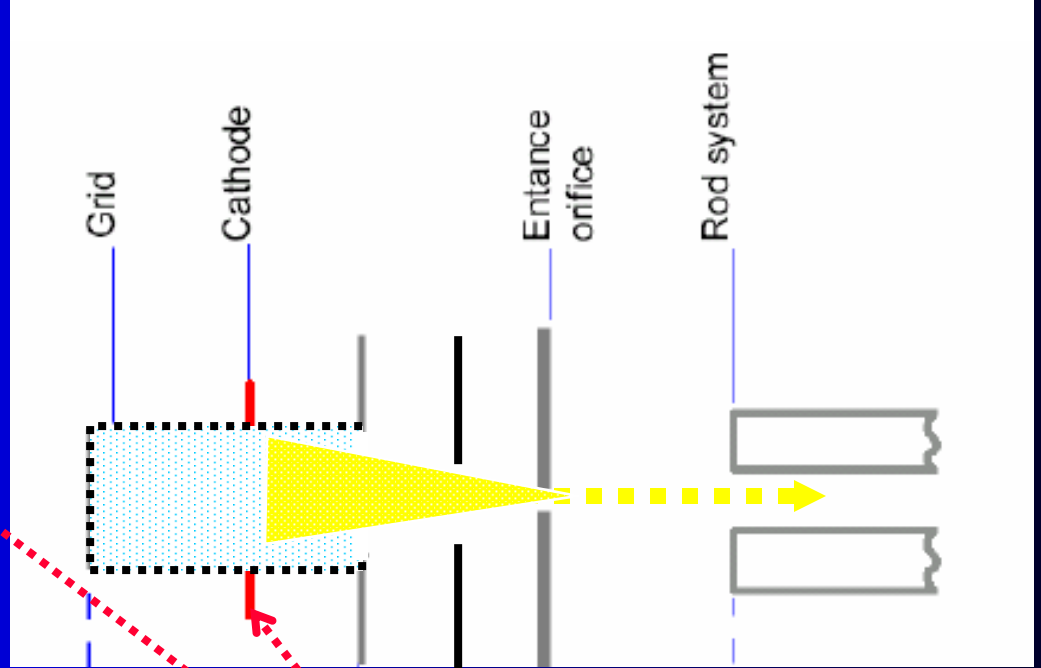
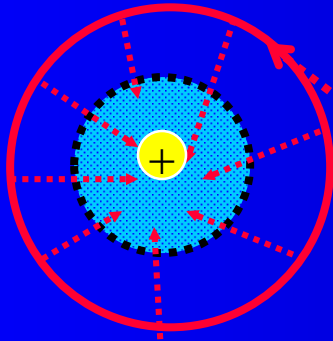

FIG. 13.19. Variation of the ionization cross-section of H<sub>2</sub> near the threshold as observed by Marmet and Kerwin.

# High efficiency Grid ion source



**Ion optics**

**Mass filter**

**Filament**

## Grid ion source

- Open design
- Two filaments (W)
- Low degassing rate
  - minimum amount of material
  - Pt-Ir wires for formation chamber
  - Molybdenum filament holders
- Easy to degas via electron bombardment
- Filaments on positive potential

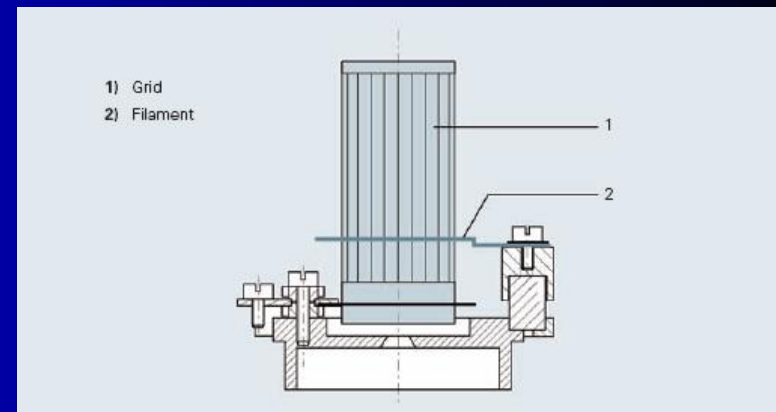
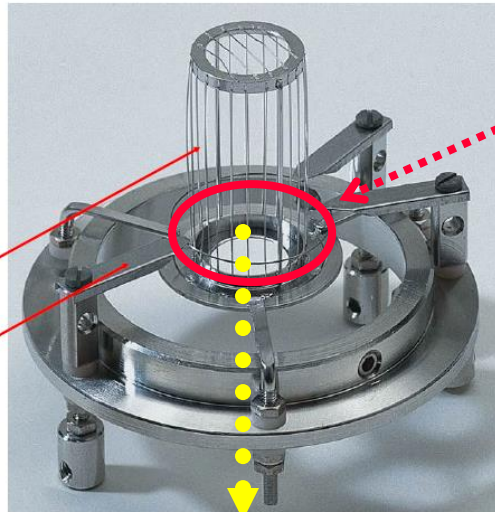

# Flight paths of electrons

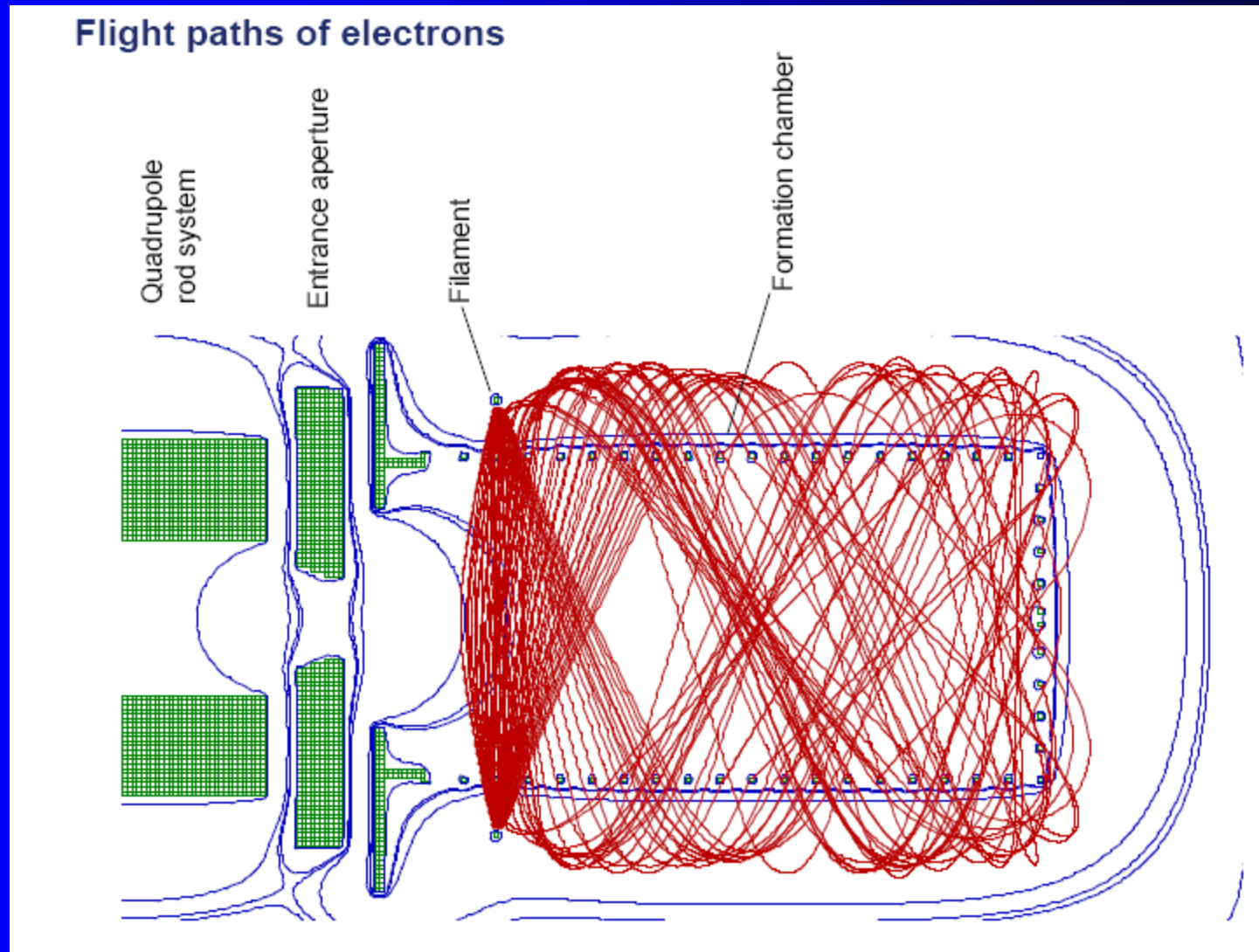



# Flight paths of electrons 3D

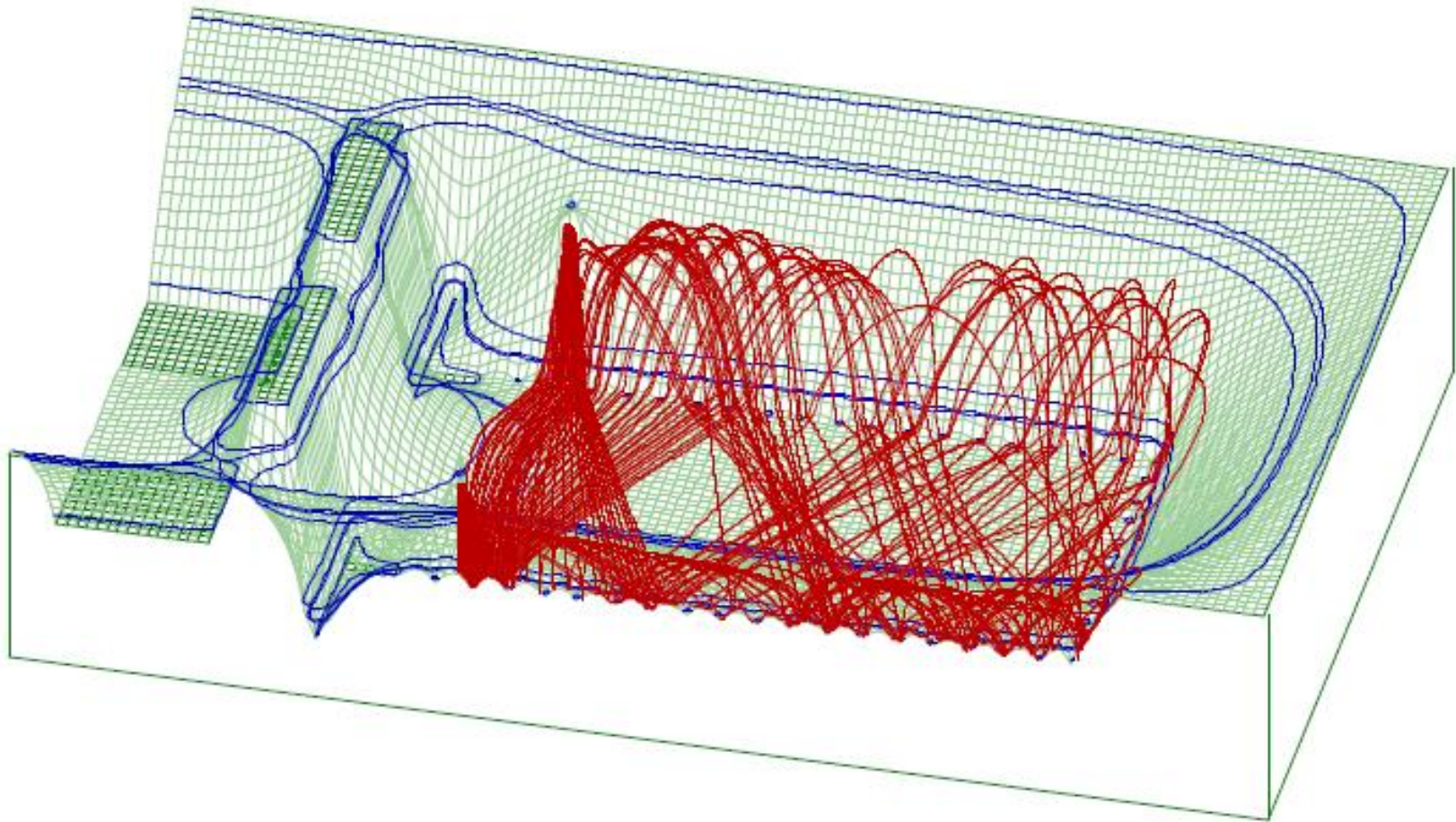

# Flight paths of positive ions

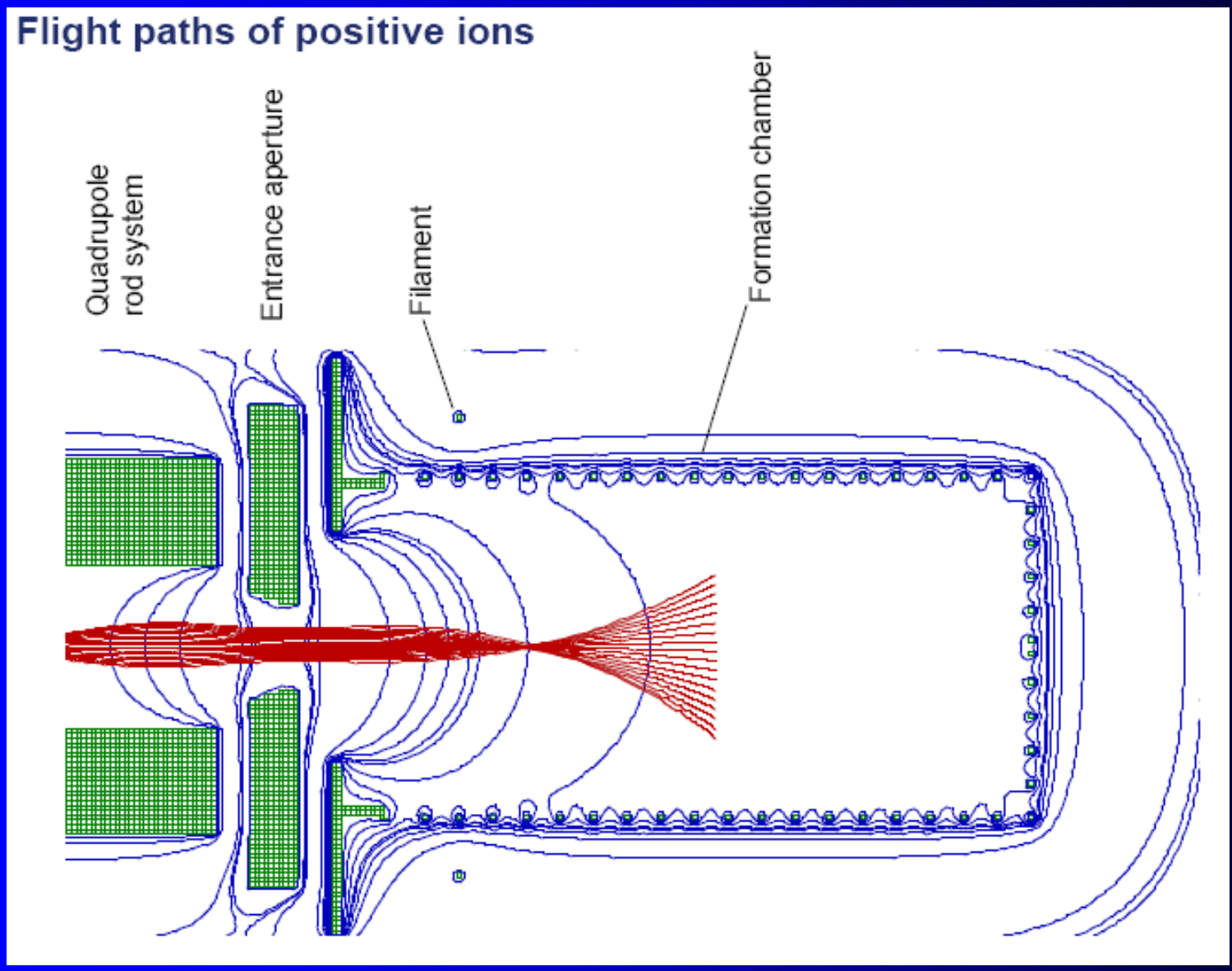



# Flight paths of ions 3D

Flight paths of positive ions

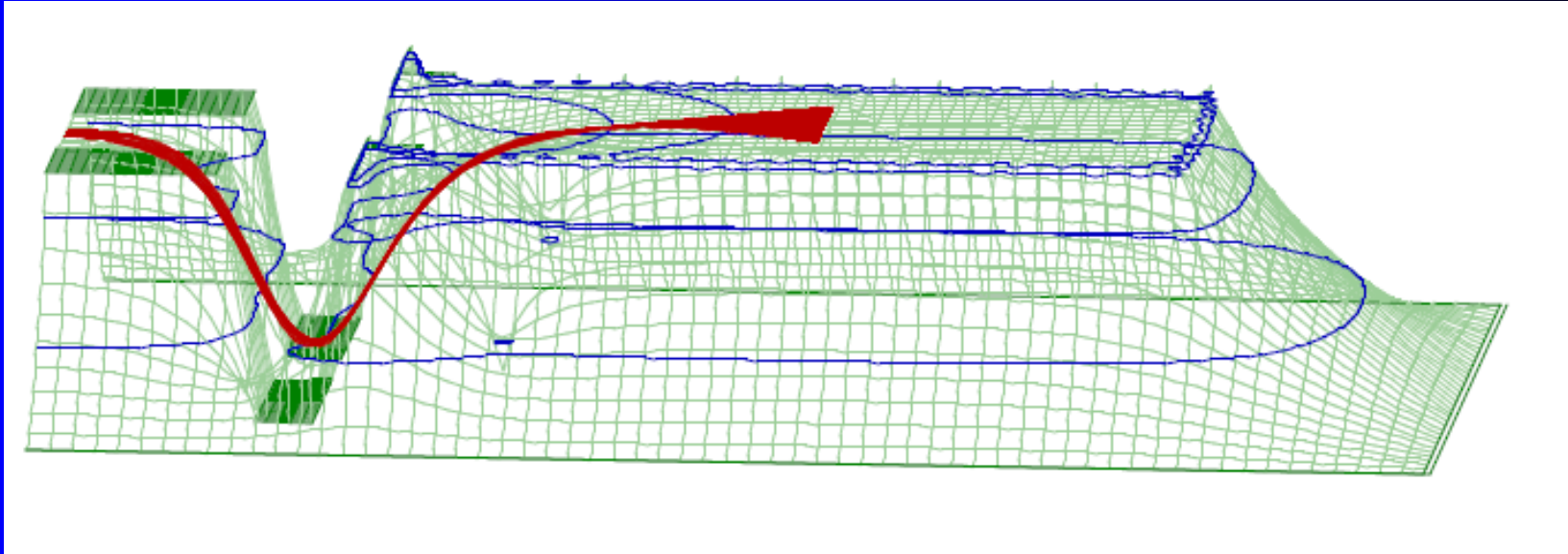
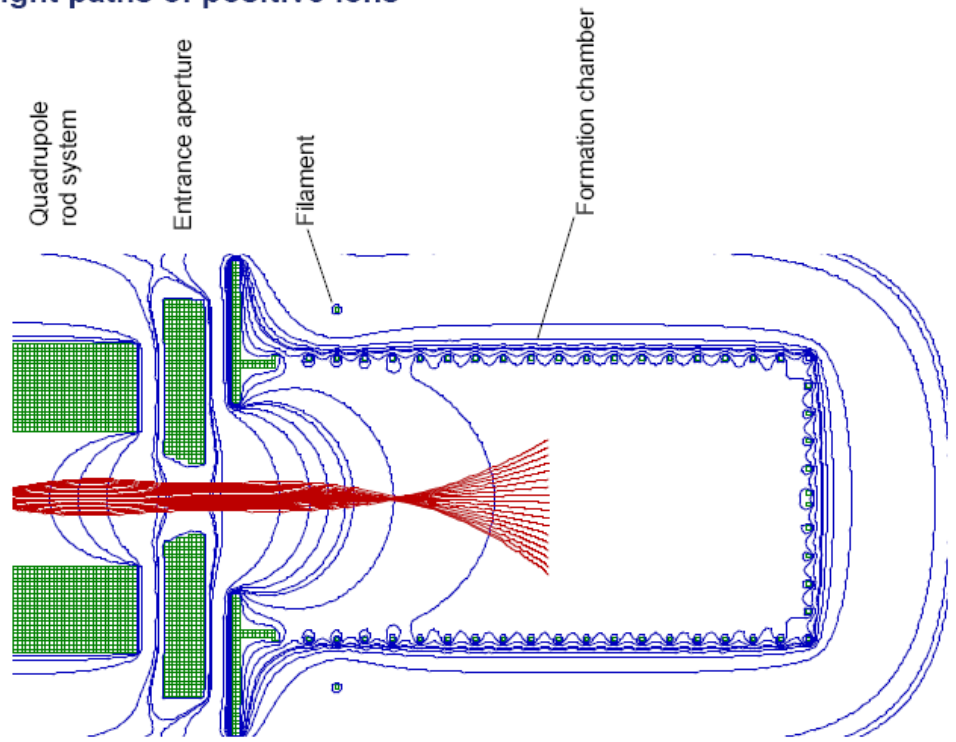

# Cross Beam ion Source, calculations

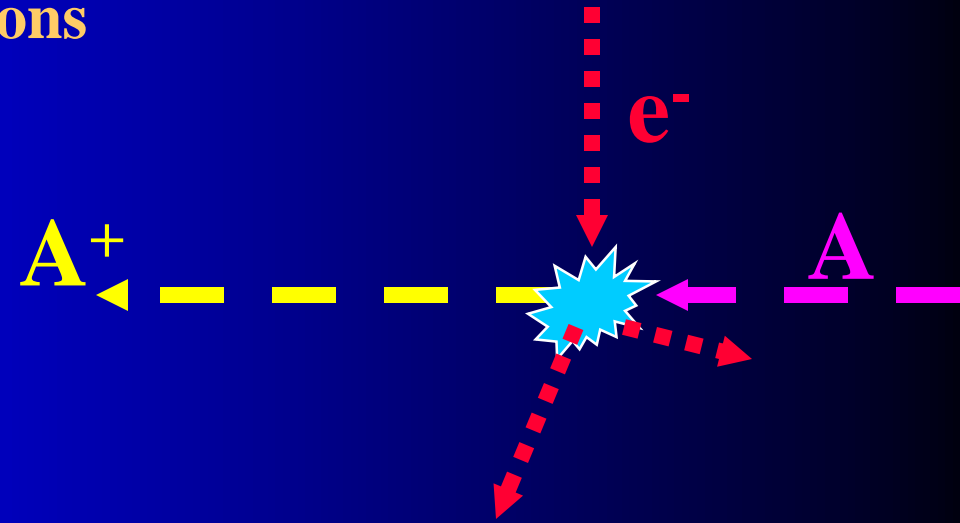
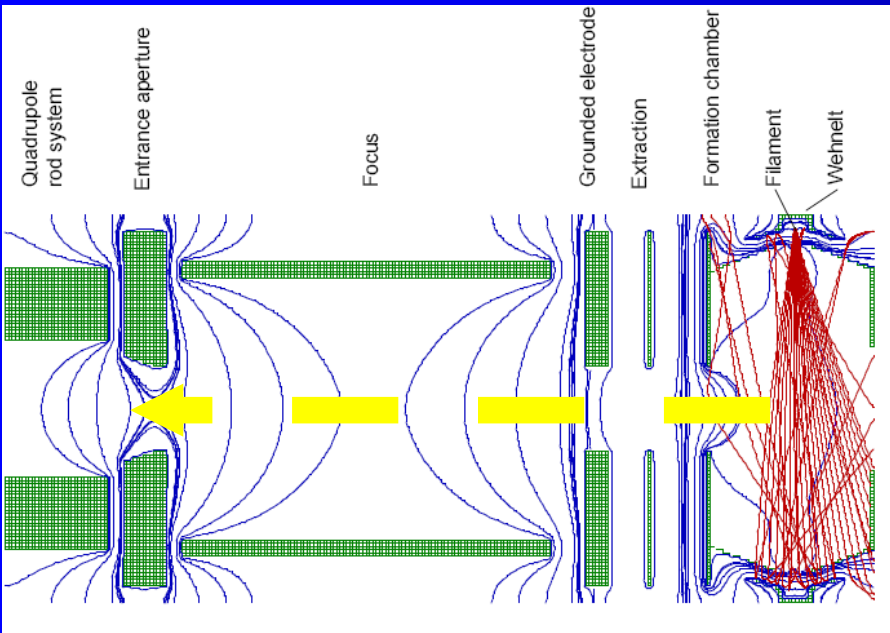

## Crossbeam ion source

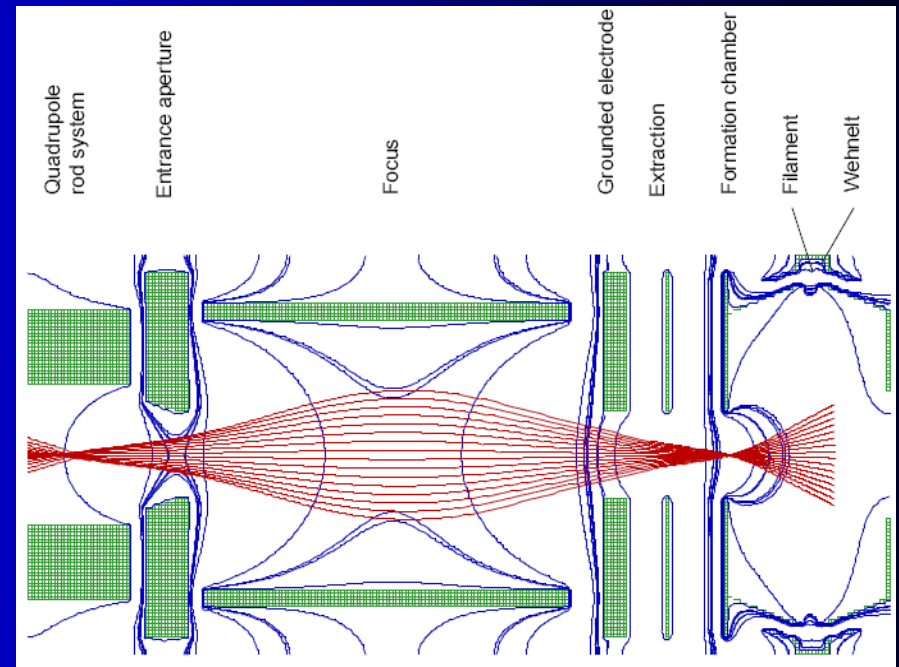
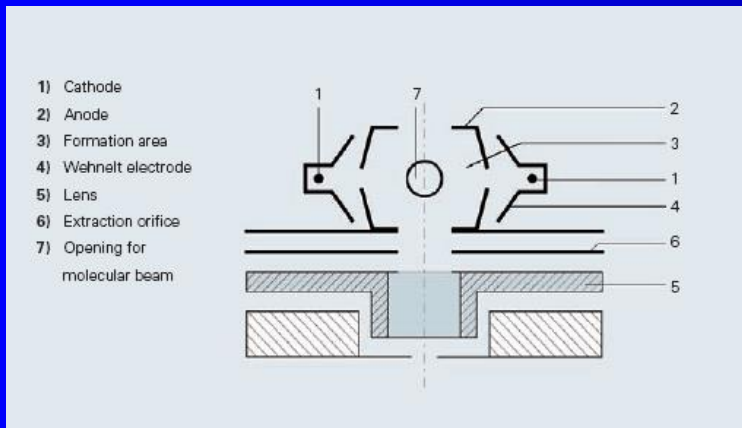

# Cross Beam ion Source

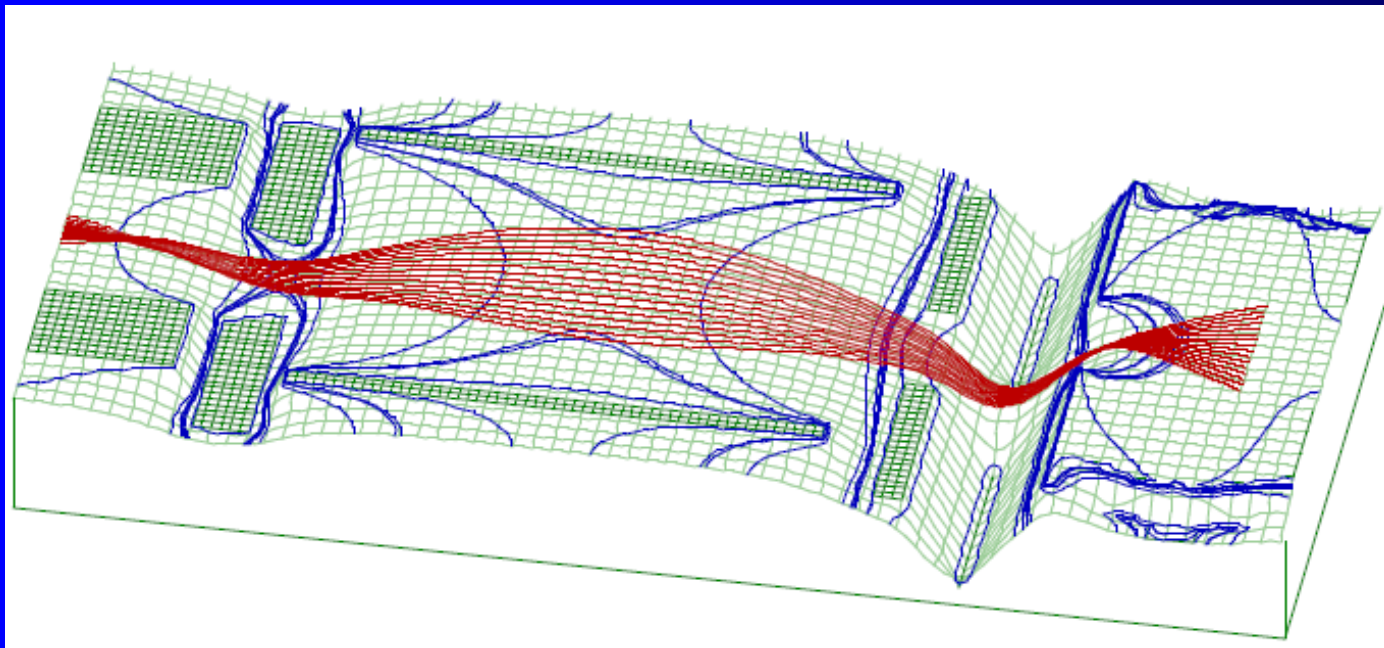

Cross Beam ion source  
with magnets

- Two filaments
- Easy to degas
- Good ion focussing
- Bakeable to 300°C

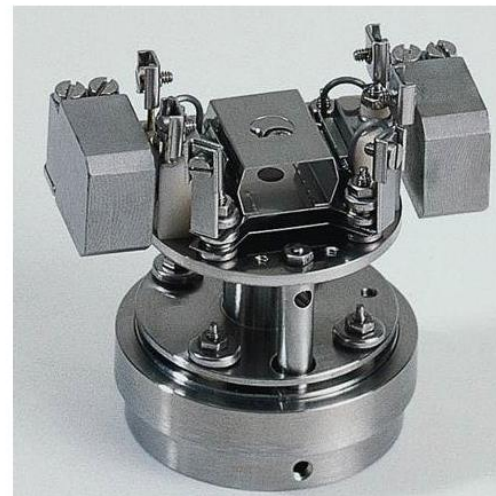

# Mass spectrometer



16 mm rod system for highest resolution, stability and transmission (e.g. He/D<sub>2</sub> separation)

8 mm rod system for High-End RGA and analytical applications

6 mm rod system for common RGA

90° off axis arrangement

efficient suppression of

- photons
- fast neutral particles
- stray ions

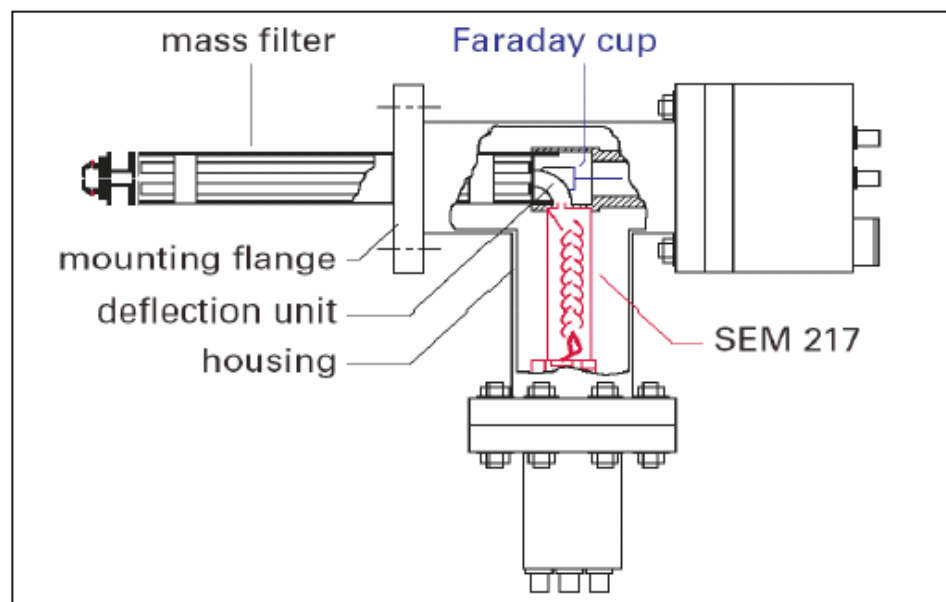

# High Resolution Mass Spectrum

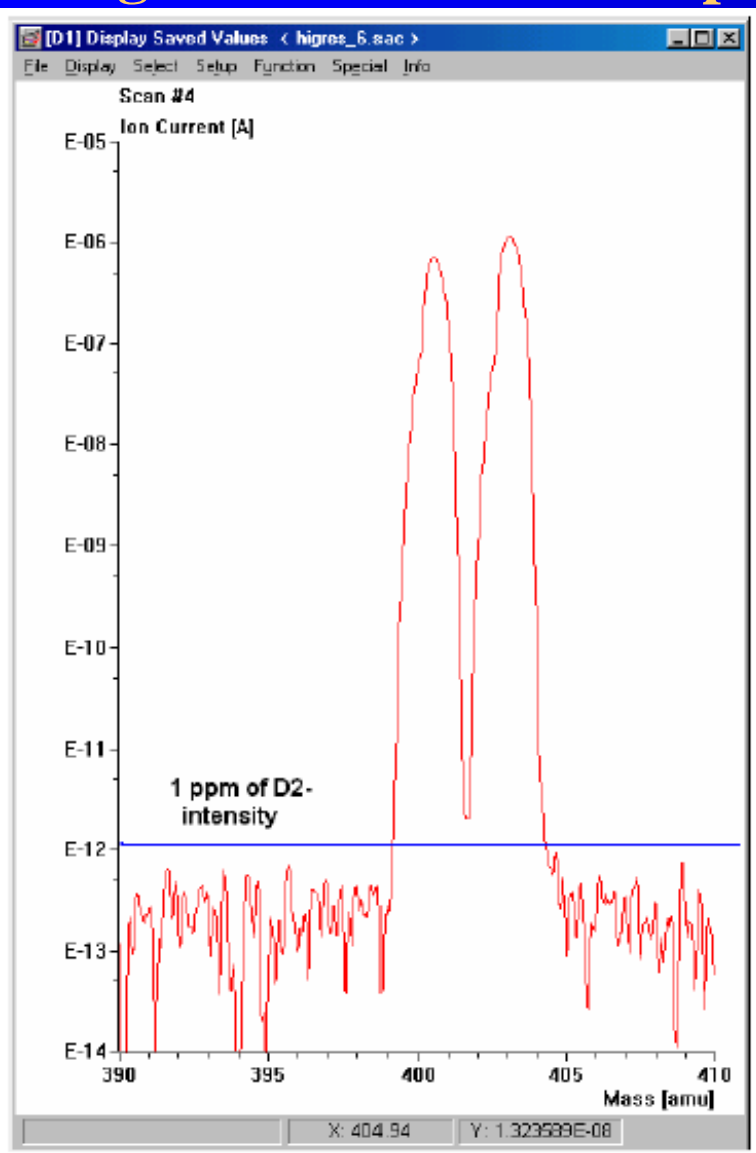

3	3He+	3.016030
	T+	3.016050
	HD+	3.021825
	H3+	3.023475
4	4He+	4.002600
	HT+	4.023875
	D2+	4.028204
	H2D+	4.029650

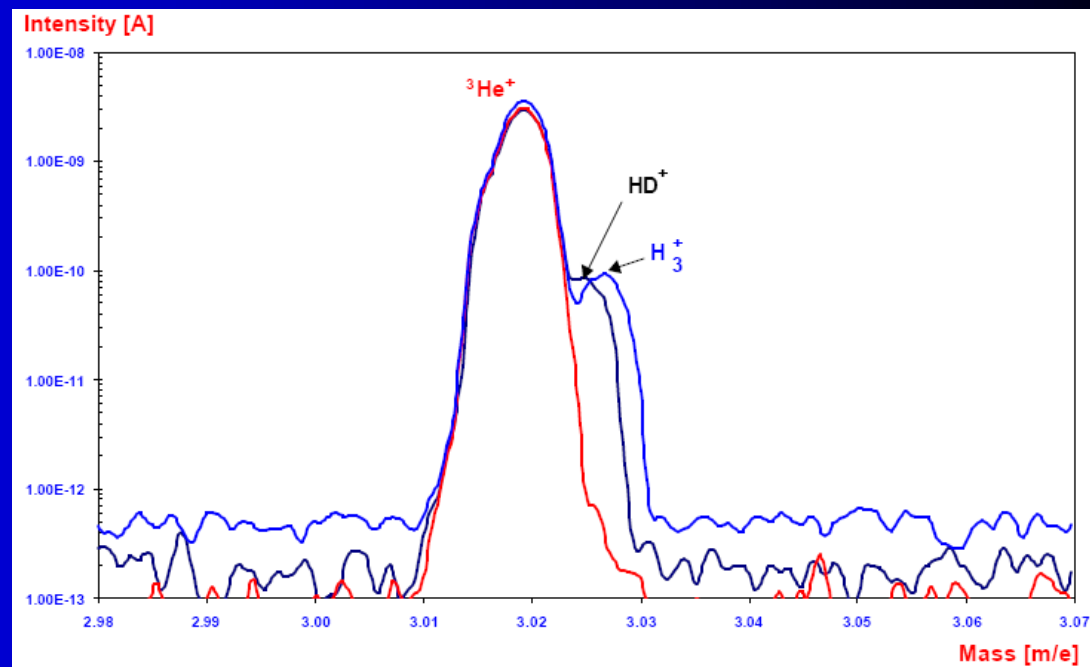



# Ion detector – Discrete dynode SEM

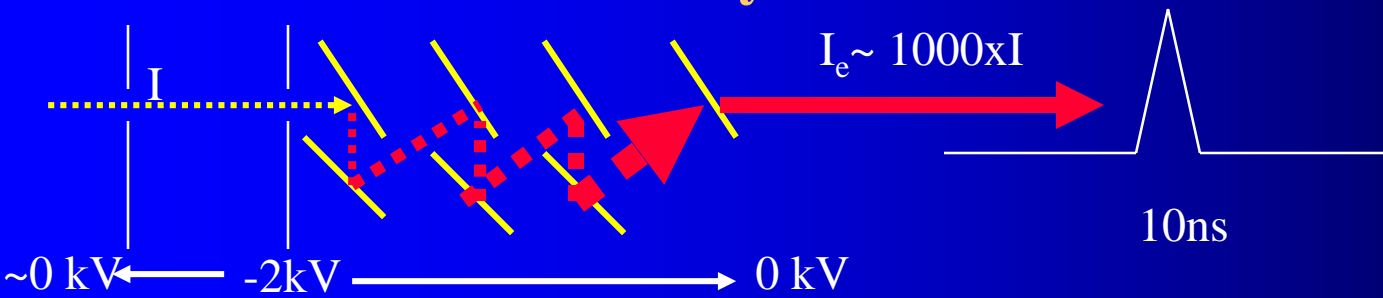

## ■ Ion Detection

- Discrete Dynode SEM
- Bakeable to  $400^\circ\text{C}$
- for analog amplification and for pulse counting
- Low noise ( $< 0.1$  cps)

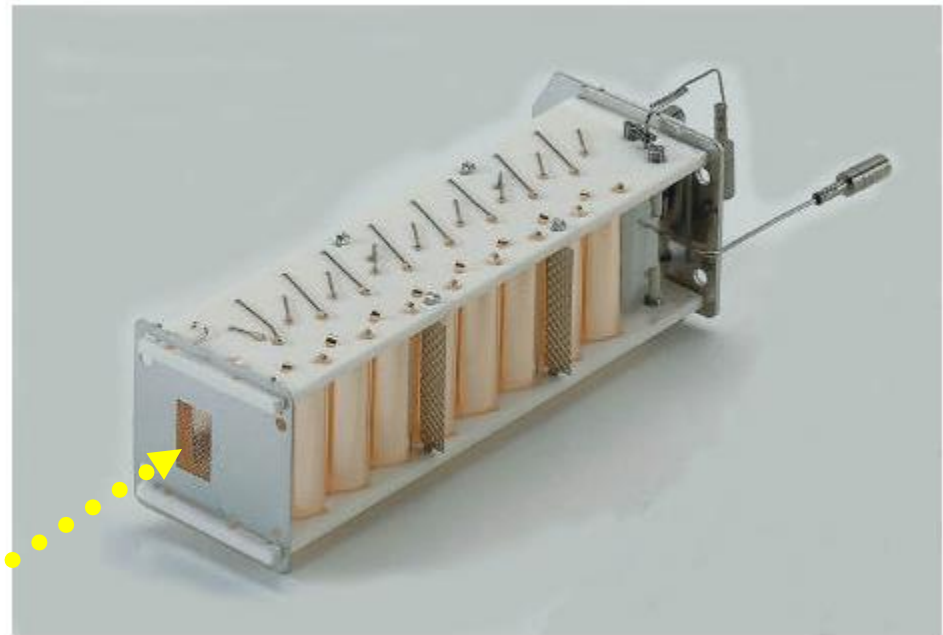

IONS

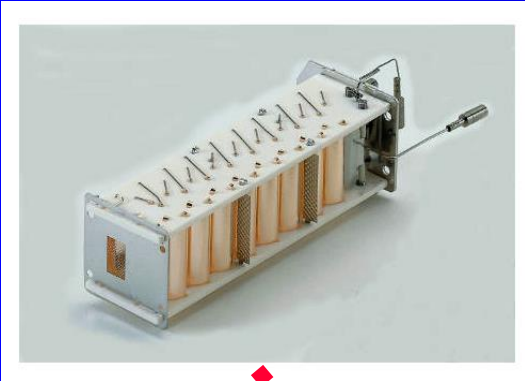

90° off axis arrangement

efficient suppression of

- photons
- fast neutral particles
- stray ions

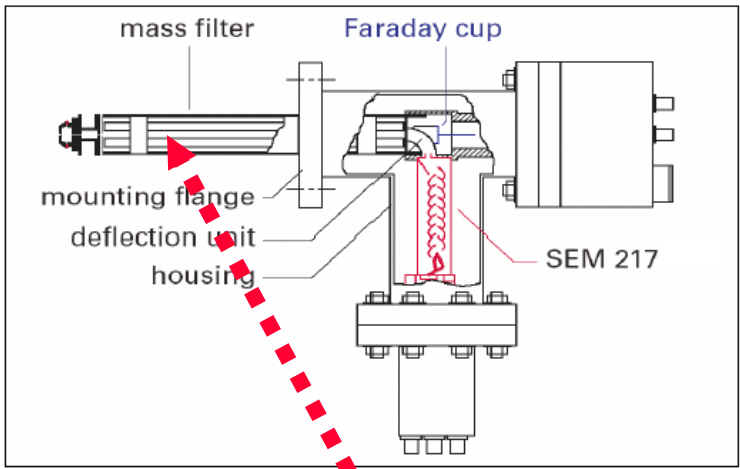

## QMA 410 with Cross Beam ion source and 90° off axis SEM

Preamplifier

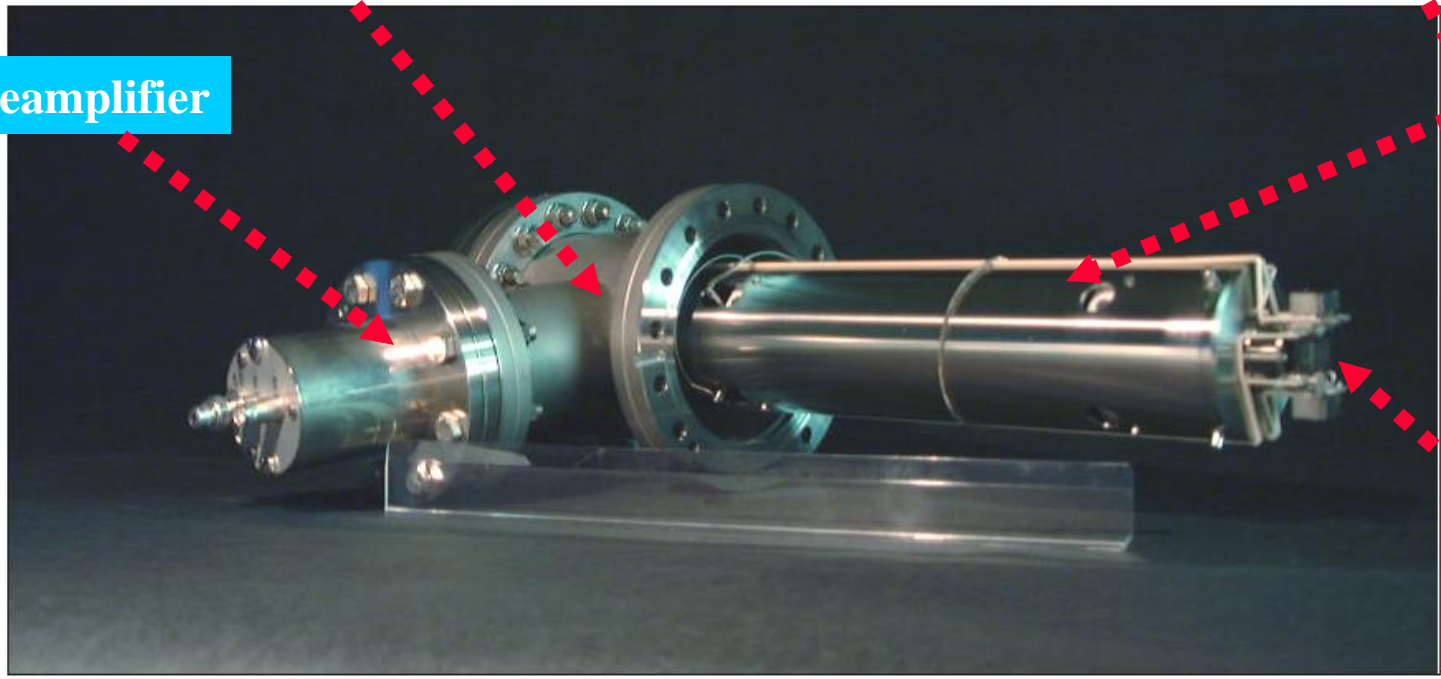

Cross Beam SOURCE



# Mass spectrum

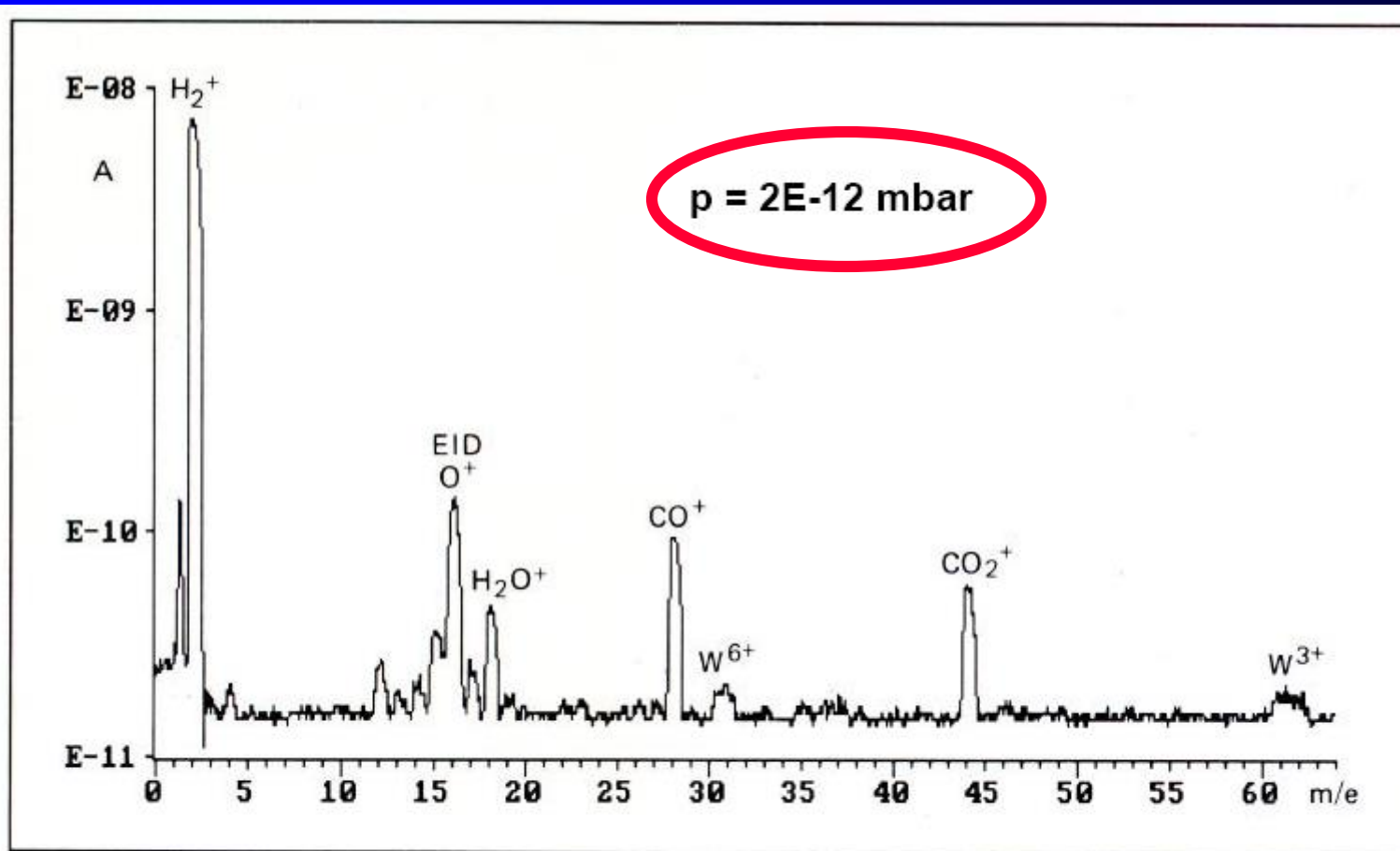

W.K. Huber, N. Müller, and G. Rettinghaus, *Vacuum*, 41, 2103 (1990)

Typical UHV spectrum

$E/k \leftrightarrow T$   
 1eV ~ 11 400 K  
 1K ~  $9 \times 10^{-5}$  eV

Electron impact rot. vibr. excitation/deexcitation  $\text{H}_3^+$

$k = \langle v\sigma \rangle \sim 4 \times 10^{-7} \text{ cm}^3 \text{ s}^{-1} \text{ SF}_6$

$k \sim 4 \times 10^{-6} \text{ cm}^3 \text{ s}^{-1} \text{ H}_5^+ + \text{e}^-$

$k_{\text{rec}} \text{ H}_3^+ + \text{e}^-$

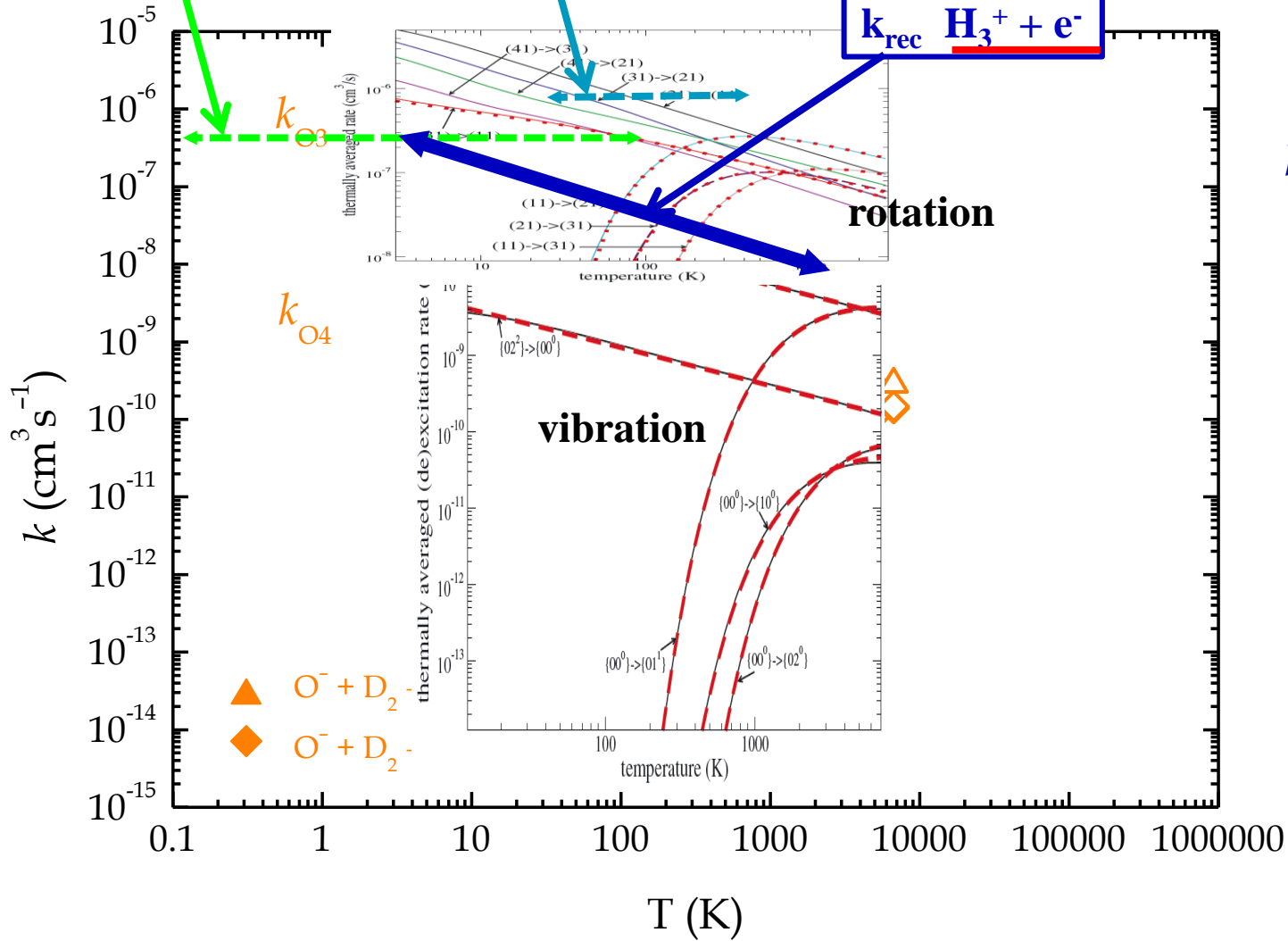

$E/k \leftrightarrow T$   
1eV ~ 11 400 K  
1K ~  $9 \times 10^{-5}$  eV

# Electron impact rotational excitation of ArH<sup>+</sup>

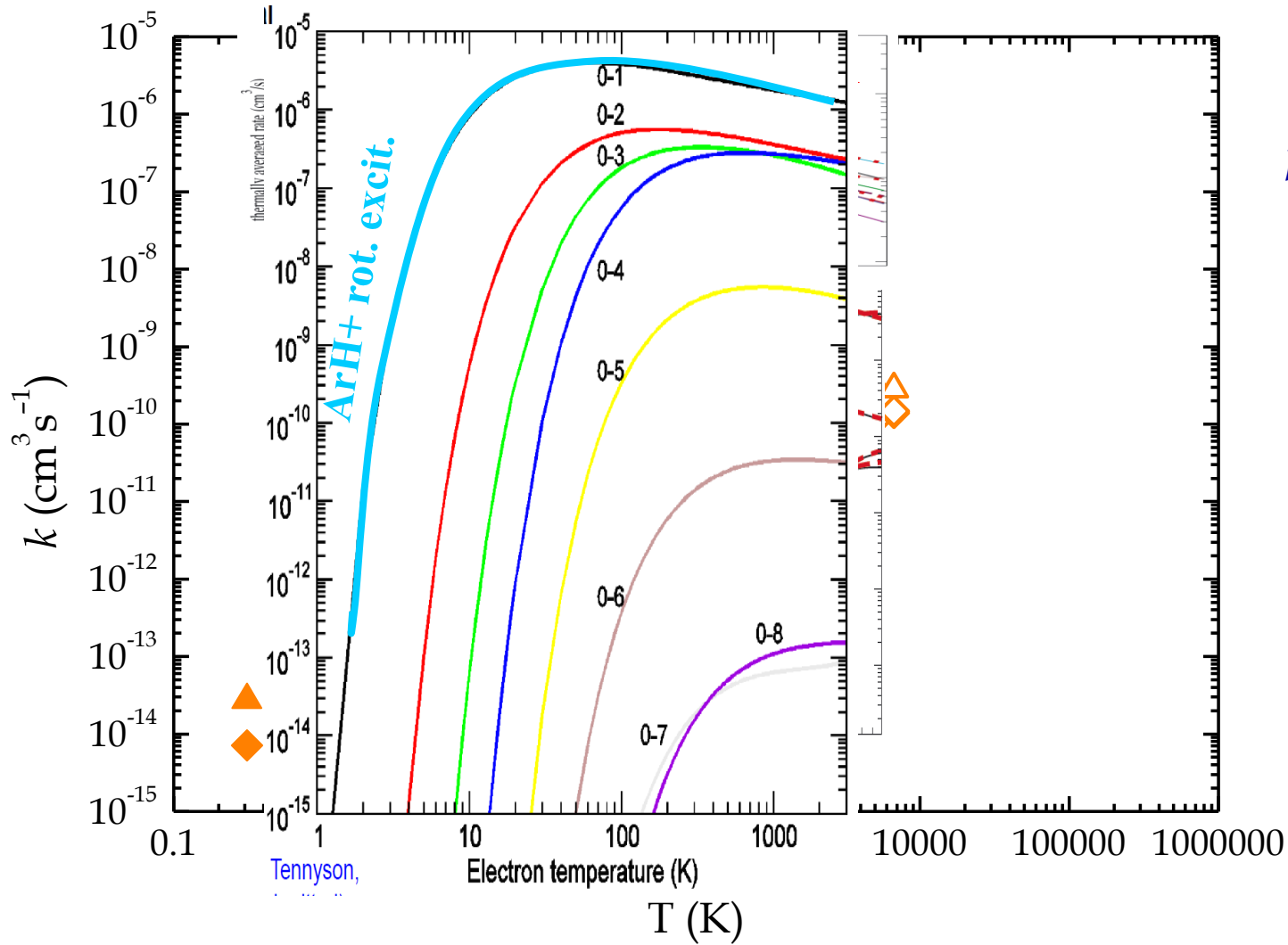

$E/k \leftrightarrow T$   
 1eV ~ 11 400 K  
 1K ~  $9 \times 10^{-5}$  eV

Electron impact rot. vibr. excitation/deexcitation  $H_3^+$

$k = \langle v\sigma \rangle \sim 4 \times 10^{-7} \text{ cm}^3 \text{ s}^{-1} \text{ SF}_6$

$k \sim 4 \times 10^{-6} \text{ cm}^3 \text{ s}^{-1} H_5^+ + e^-$

$k_{\text{rec}} H_3^+ + e^-$

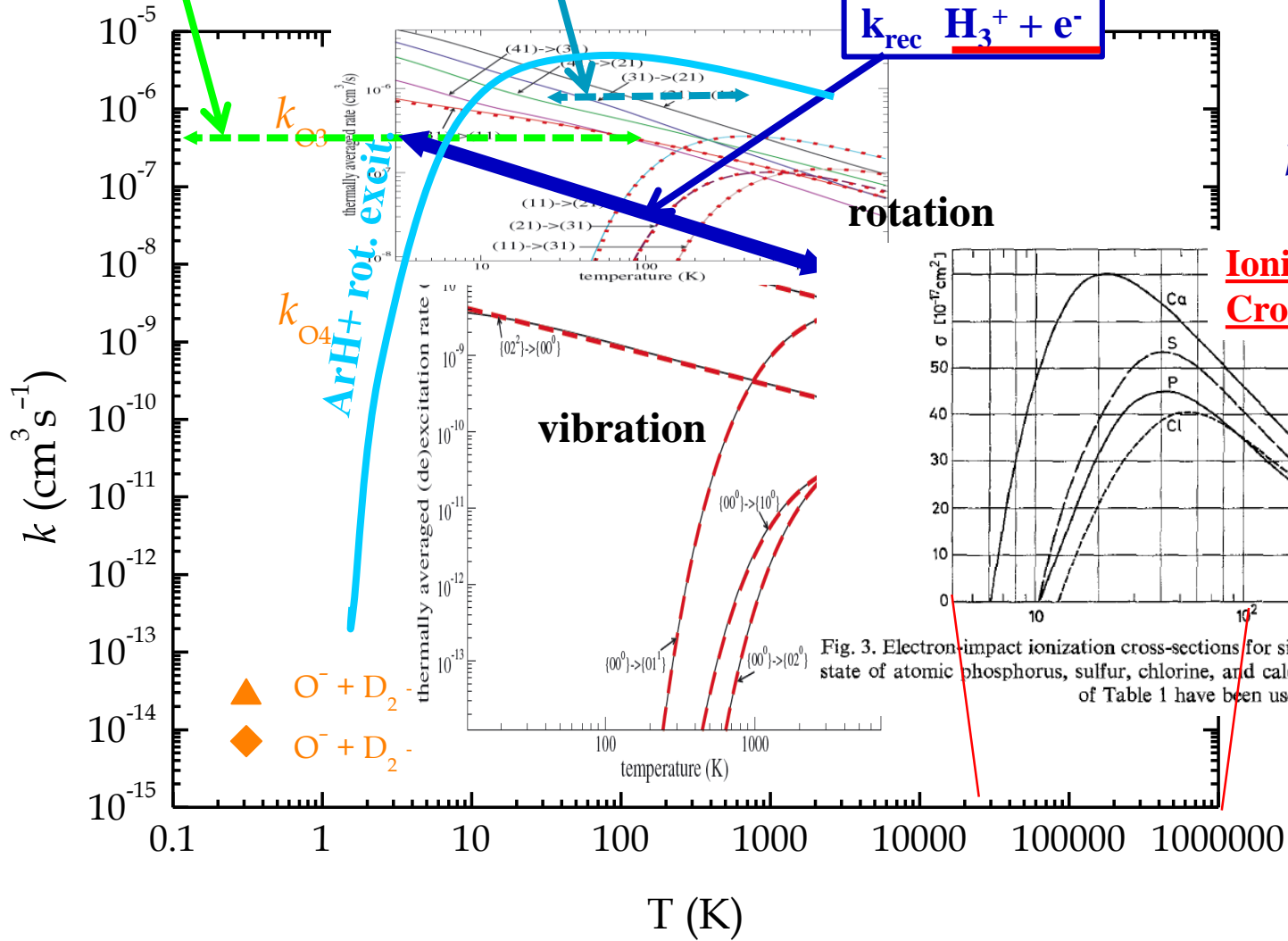

Fig. 3. Electron-impact ionization cross-sections for single ionization from the ground state of atomic phosphorus, sulfur, chlorine, and calcium. Formula (1) and the data of Table 1 have been used

$E/k \leftrightarrow T$   
 1eV ~ 11 400 K  
 1K ~  $9 \times 10^{-5}$  eV

Electron impact rot. vibr. excitation/deexcitation  $\text{H}_3^+$

$k = \langle v\sigma \rangle \sim 4 \times 10^{-7} \text{ cm}^3 \text{ s}^{-1} \text{ SF}_6$

$k \sim 4 \times 10^{-6} \text{ cm}^3 \text{ s}^{-1} \text{ H}_5^+ + e^-$

$k_{\text{rec}} \text{ H}_3^+ + e^-$

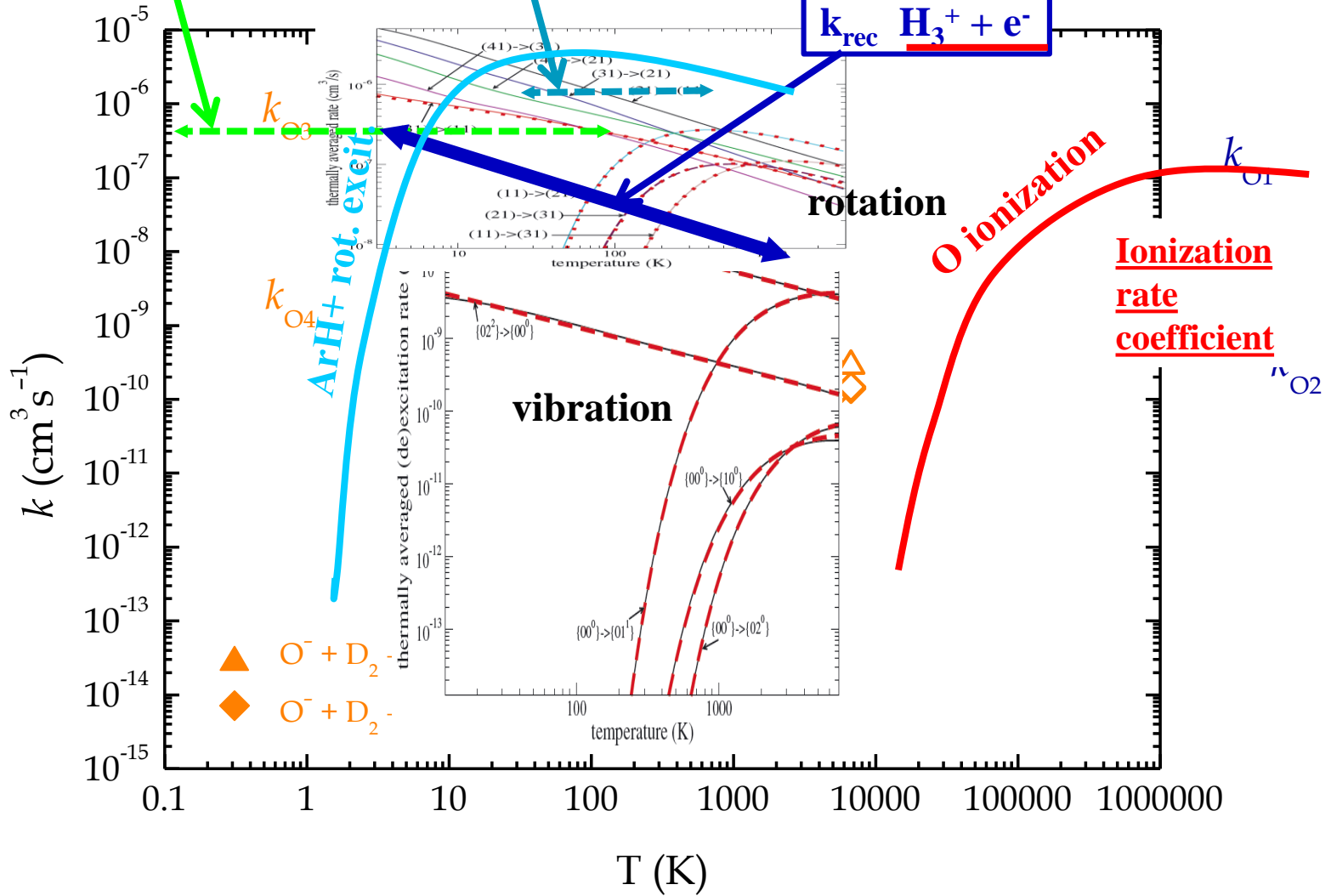

$E/k \leftrightarrow T$   
 1eV ~ 11 400 K  
 1K ~  $9 \times 10^{-5}$  eV

Electron impact rot. vibr. excitation/deexcitation  $H_3^+$

$k = \langle v\sigma \rangle \sim 4 \times 10^{-7} \text{ cm}^3 \text{ s}^{-1} \text{ SF}_6$

$k \sim 4 \times 10^{-6} \text{ cm}^3 \text{ s}^{-1} \text{ H}_5^+ + e^-$

$k_{\text{rec}} \text{ H}_3^+ + e^-$

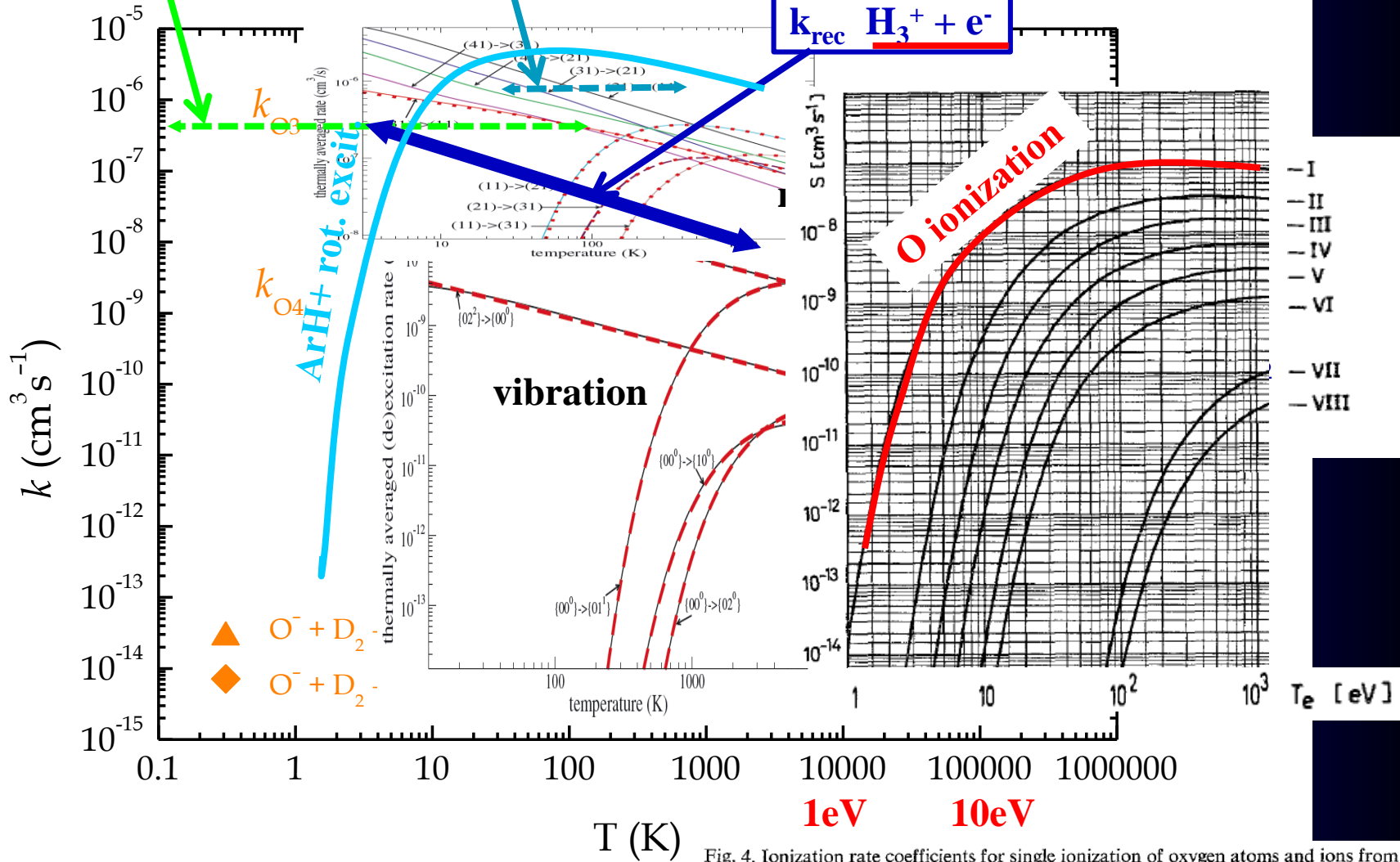

Fig. 4. Ionization rate coefficients for single ionization of oxygen atoms and ions from the ground state by electron-impact in a tenuous plasma (Maxwellian distribution, no lowering of ionization potential, no collision limit)

See You next week



