

# INTERDISCIPLINARY APPROACHES TO LANGUAGE AND ITS USE II.

Data collection

**Jan Chromý**



**FACULTY OF ARTS**  
Charles University



# DATA COLLECTION TECHNIQUES



questionnaire



interview



observation



# QUESTIONNAIRE

indirect

- attitudes
- beliefs about language use

direct

- elicited language use



# QUESTIONNAIRE AS A DIRECT TECHNIQUE

- What is on the picture?

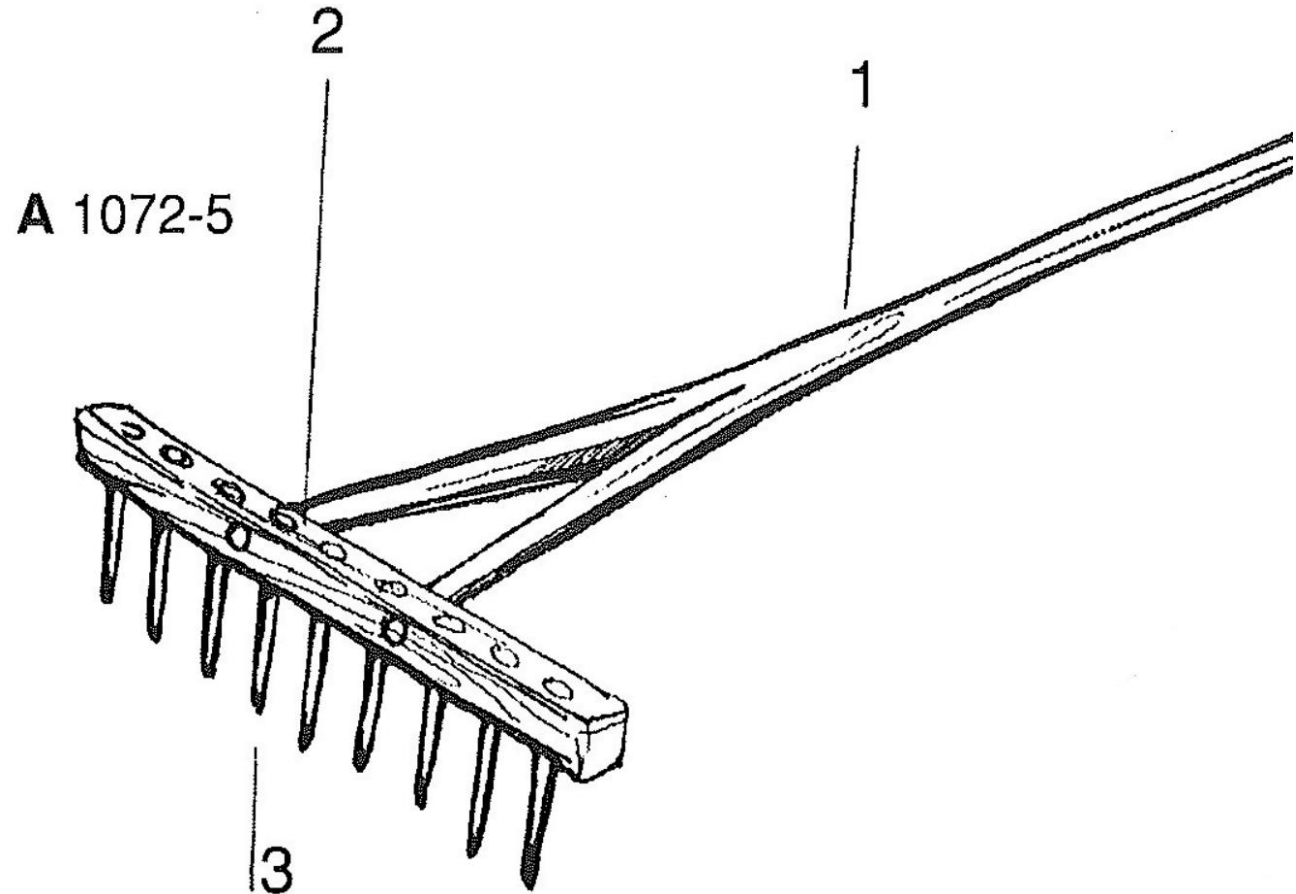

# QUESTIONNAIRE



## **pros**

targetting  
quick data collection

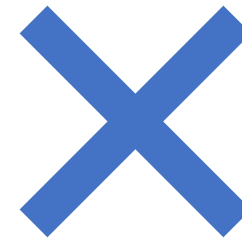

## **cons**

inaccuracy  
brevity



# SOCIOLINGUISTIC INTERVIEW

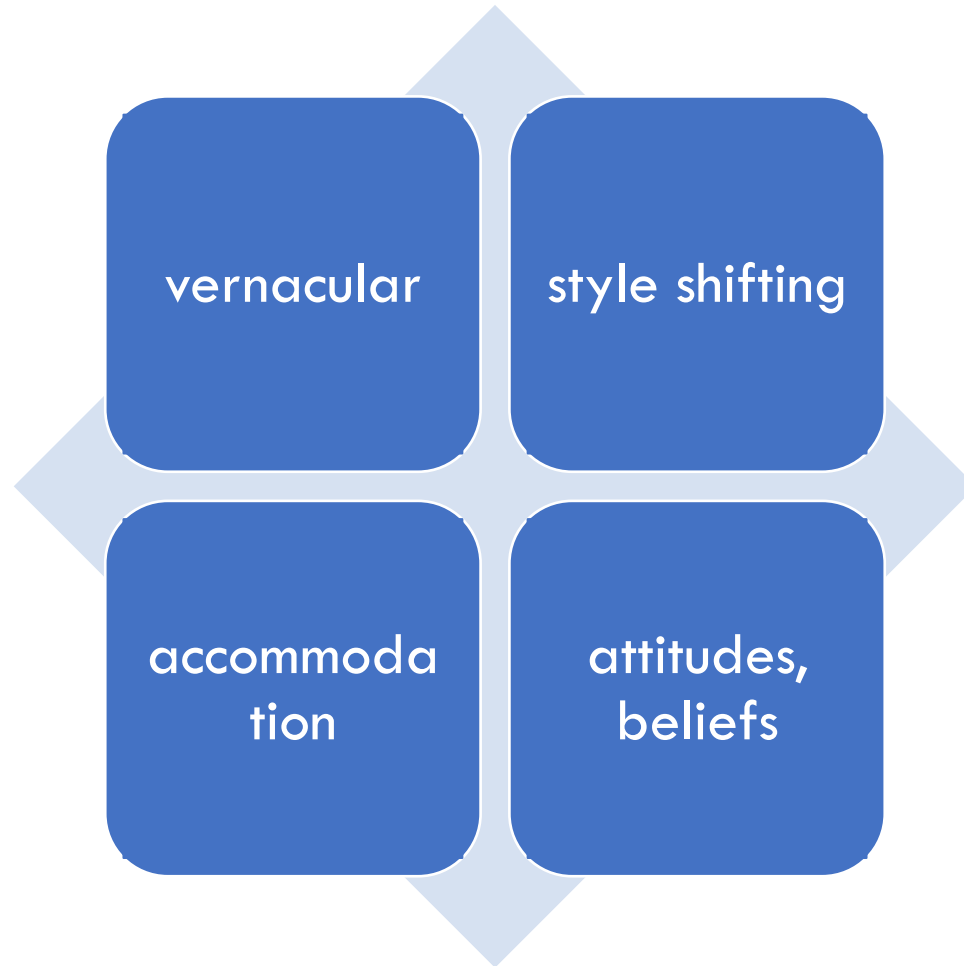

# INTERVIEW



## **pros**

direct contact  
natural production

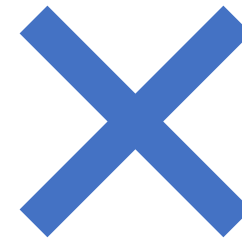

## **cons**

demanding  
unsuitable for certain aims



# PROBLEMS



observer's paradox



explanation

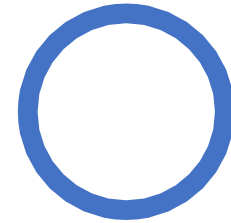

absence vs. non-  
existence





# OBSERVATION

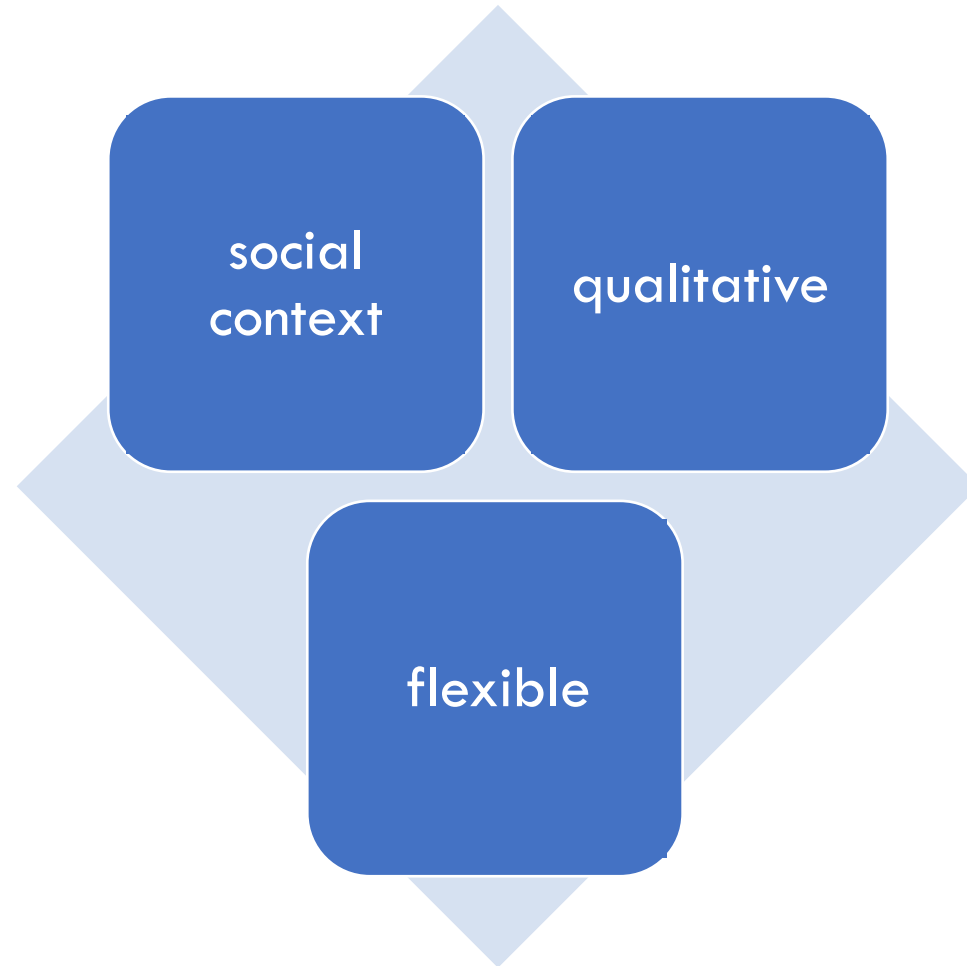

# OBSERVATION



## **pros**

detailed information  
explanation

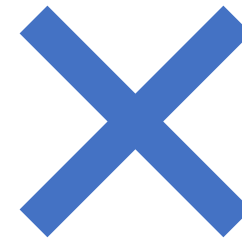

## **cons**

extremely demanding  
no quantification



# READING TIPS

- Milroy, L. & Gordon, M. (2003). *Sociolinguistics: Method and Interpretation*. Oxford: Blackwell. (chap. 3)
- Tagliamonte, S. (2006). *Analysing Sociolinguistic Variation*. Cambridge: Cambridge Univ. Press.

