

The Decapolis: History and Archaeology

7 Archaeology of the Roman period III – Public spectacles and entertainment structures

WEISS, Z. 2014: *Public Spectacles in Roman and Late Antique Palestine*. Cambridge, London.

SEGAL, A. 1995: *Theatres in Roman Palestine and Provincia Arabia*. Leiden, New York and Köln.

Public Games

- *Agon, agones* in Gr., *ludus, ludi* in Lat.
- Another integral part of the city life in ancient Greek and Roman cities
- Either connected to the religious festivals (worship, thanksgiving) – typical city would have had at least one such festival and games in honour of its patron deity, or
- Funeral rites, or
- Imperial propaganda and benefaction (more common in the Roman period)
- In fact, all games originated as religious in nature, from the 1st c. BCE they began to be increasingly secularized and under the High Empire (1st-3rd c. CE) most games are completely detached from religion (but religious festivals with games still exist) → become a “spectacle”

- 1) Theatrical performances (theatre, music, rhetorics)
- 2) Agonistic competition (athletic)
- 3) Horse races
- 4) Gladiatorial fights (incl. *venationes* – animal hunts and *naumachia* – water plays/battles)

- Always a competition for an award – cities would honour the winners with gifts, even statues
- Private, public and Imperial donations to the games
- Each type of games requires different setting

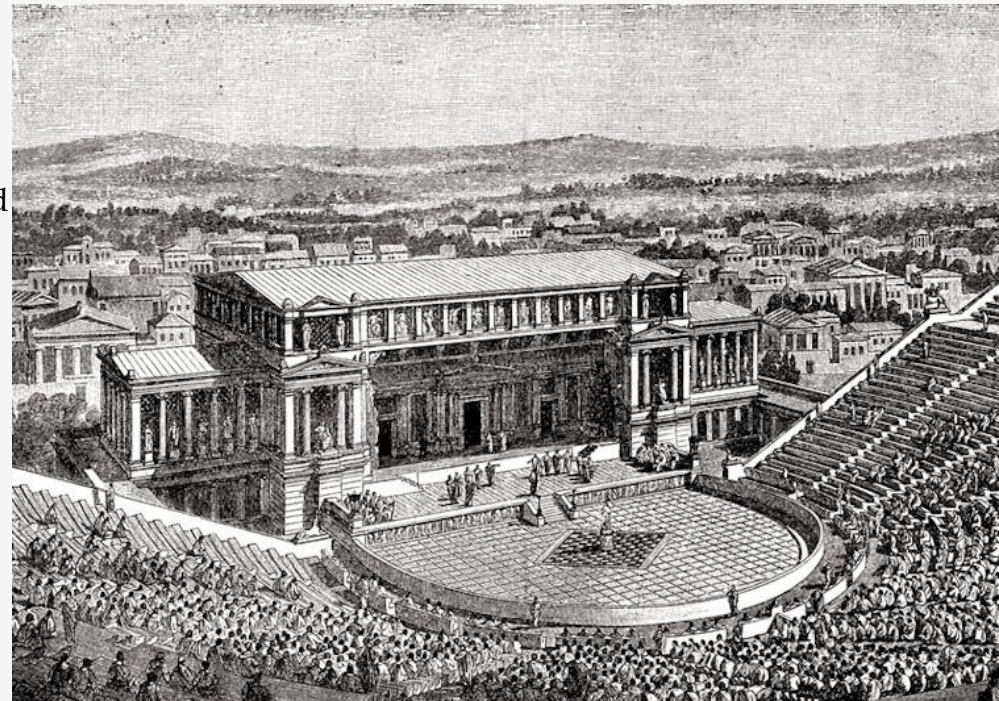

Public Games

- Very little evidence for public games in the Levant in the Hellenistic period
- The only known and extant structure is a stadium in Marathos (modern Amrit, Syria, on the Phoenician coast)
- Ca. 230x40 m, stepped seating arrangement, hewn into the bedrock
- Dated to the 4th/3rd c. BCE, the site is abandoned in the 2nd c. BCE
- Connection to the religious festivals at the nearby temple/funerary games for the kings?



Public Games

- Theatrical, athletical and gladiatorial games and horse races were at the latest introduced into the Levant by Herod
- Games become increasingly widespread from the 1st c. CE
- Construction boom, as in other cases, falls within 2nd-3rd c. CE

“On this account it was that Herod revolted from the laws of his country, and **corrupted their ancient constitution, by the introduction of foreign practices**, which constitution yet ought to have been preserved inviolable; by which means we became guilty of great wickedness afterward, while those religious observances which used to lead the multitude to piety were now neglected; for, in the first place, **he appointed solemn games to be celebrated every fifth year, in honour of Caesar** [i.e. commemorating Octavian – Augustus’s victory over Marc Antony at Actium in 31 BCE], and **built a theatre at Jerusalem, as also a very great amphitheatre in the plain**. Both of them were indeed costly works, but **opposite to the Jewish customs**; for we have had no such shows delivered down to us as fit to be used or exhibited by us; yet did he celebrate these games every five years, in the most solemn and splendid manner. He also made proclamation to the neighbouring countries, and called men together out of every nation. **The wrestlers also, and the rest of those that strove for the prizes in such games, were invited out of every land**, both by the hopes of the rewards there to be bestowed, and by the glory of victory to be there gained... He had also made a great preparation of **wild beasts, and of lions** themselves in great abundance, and of such other beasts as were either of uncommon strength, or of such a sort as were rarely seen. These were prepared either to **fight with one another, or that men who were condemned to death were to fight with them.**” AJ 15.267-275 (ca. 28 BCE)

- It is indicative that Josephus considers the introduction of games as a total novelty (but perhaps reflects only Jewish point of view)
- Jewish opposition to the games (especially gladiatorial fights)

Public Games

- Herod built theatres and hippodromes in Caesarea Maritima, Jericho, Jerusalem and Herodium
- His intentions were largely political – self-representation as a Hellenistic ruler, Roman aristocrat and client of the Emperor, therefore he is adopting Hellenistic/Roman cultural norms
- The emergence of entertainment structures after Herod may function as a proxy for Hellenization/Romanization of local population
- Very specific case is proliferation of amphitheatres from the 2nd/3rd c. CE – a purely Roman form for a purely Roman spectacle (gladiatorial fights)

“He who goes to the theatres of gentiles. **If he goes because of the need of the state, then it is permitted. If he appreciates [what goes on inside], then it is forbidden. If he sits in a stadium (where gladiators fight), then he is guilty of bloodshed.** R. Nathan permits [going] on two counts: because [the Jew] cries out to save lives, and because he testifies on behalf of a woman (whose husband is killed in the arena) so she can remarry. . . . They go to the stadiums because [a Jew] will cry out to save lives, and to the circus in order to settle matters of the state, but if he appreciates [what goes on inside], then it is forbidden.” Talmud, Avodah Zarah 2,7

- The Jewish Rabbis in general discouraged or even forbid attendance of theatres and other public entertainment structures
- The Talmudic passage shows that it was not always possible – not only games and spectacles were carried out in those buildings

Entertainment structures

Theatres

- Originally for theatrical performances (tragedies, comedies and satyr plays) during festivities of the Dionysus cult
- Gradually secularized, in the Roman period most popular was pantomime (expressive dance and singing)
- Theatre is suitable for performative arts (theatre, music, dance, rhetoric)
- Some could have been adapted for water plays and gladiatorial fights
- “Greek” (on natural slope) x “Roman” (built, tall multi-storeyed *scaena*) → the distinction does not really work, as many theatres in the Roman period are both built on natural slope and raised above it on vaulted substructure where needed
- Most theatres are built in the Roman style, where side wings of *scaenae frons* are attached to the side ends of the *cavea* and reaching the same height
- Seating - thousands

Scaena (*scaenae frons*), orchestra, *cavea*

Cunei - seating between rows of stairs

Vomitorium - arched passage leading to *cavea*

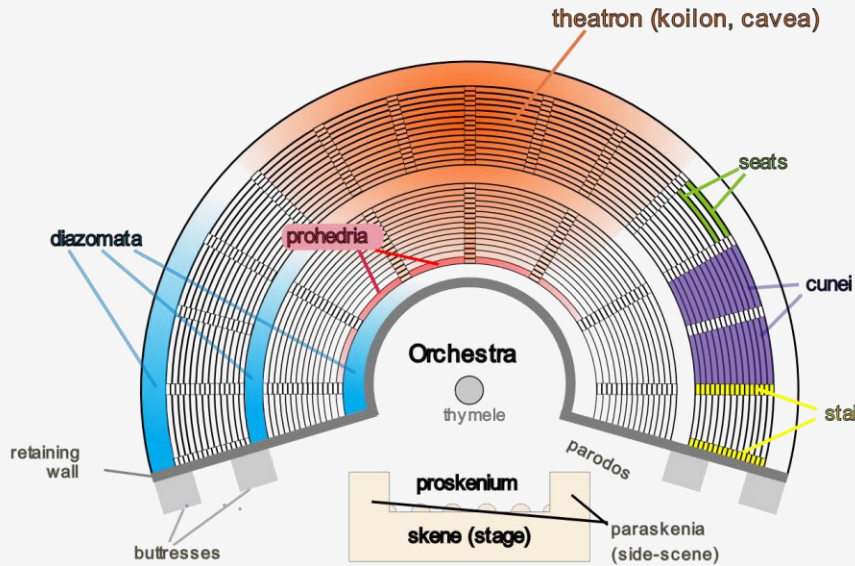

ANCIENT GREEK THEATRE

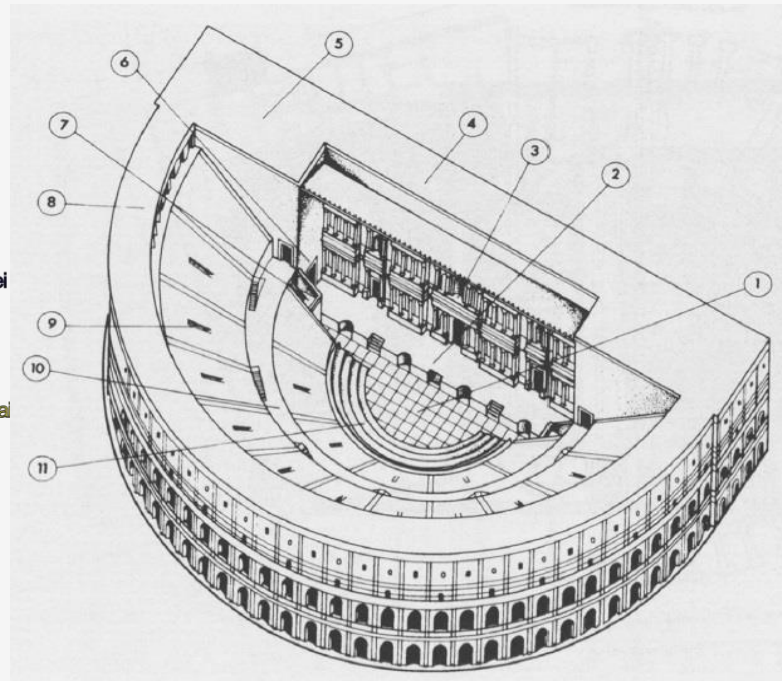

1. orchestra
2. pulpitum
3. scaenae frons
4. scaena
5. versura
6. itinera versurarum
7. tribunal
8. porticus
9. vomitorium
10. praecinctio
11. bisellia

Entertainment structures

Theatres

- Bostra, probably the best preserved Roman theatre in existence – only limestone architectural decoration of the *scaenae frons* is missing
- 2nd c. CE, $\varnothing = 67$ m, orchestra 21 m, ca. 6,000 spectators



Entertainment structures

Theatres

- Bostra, probably the best preserved Roman theatre in existence – only limestone architectural decoration of the *scaenae frons* is missing
- 2nd c. CE, $\varnothing = 67$ m, orchestra 21 m, ca. 6,000 spectators



Entertainment structures

Odeion/Odeum

- Small theatre-like structure
- Usually roofed
- Similar purpose as the theatre – mainly musical and rhetorical performances, could be used also as an assembly hall of the city council or in similar official capacity
- Seating - hundreds

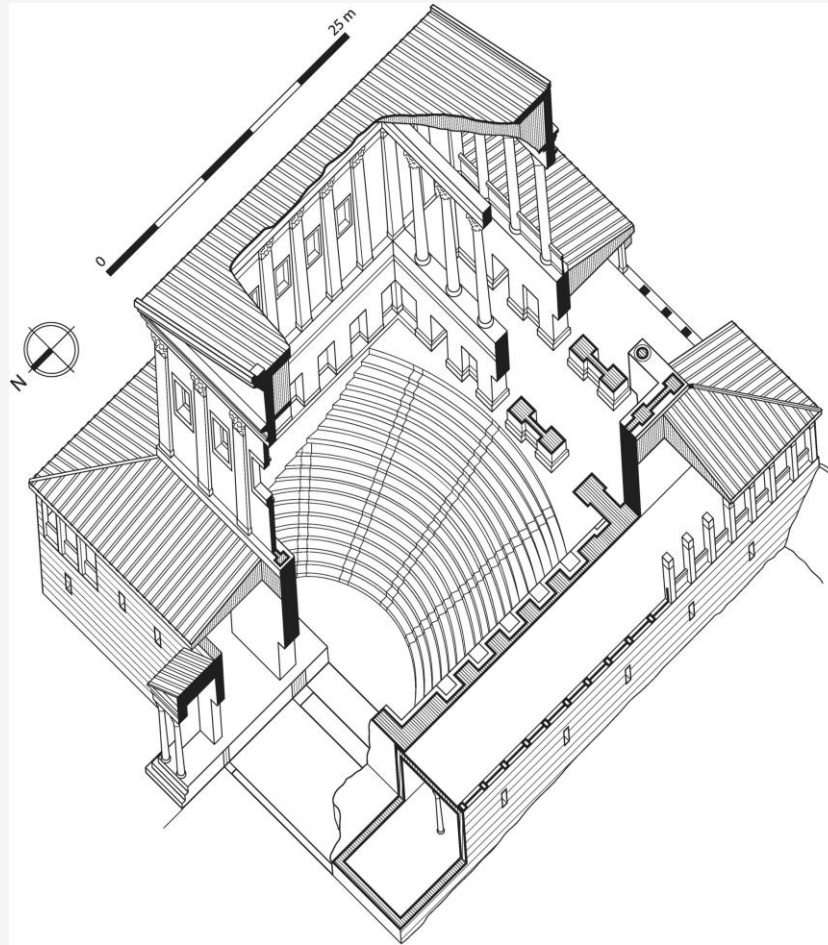

Odeion of Agrippa, Athens, late 1st c. BCE

Entertainment structures

Hippodrome/circus and stadion/stadium

- For horse races (*hippika*) and athletic games
- For some (e.g. Herodian hippodrome in Caesarea Maritima) multifunctional use (incl. gladiatorial fights etc.) is attested
- Both typically U-shaped
- Stadia for athletic games are typically narrower than hippodromes (hipp. must accommodate number of chariots)
- In the southern Levant, several hippodromes were re-built as amphitheatres in the 3rd/4th c. CE suggesting (local) shift from horse racing to gladiatorial fights

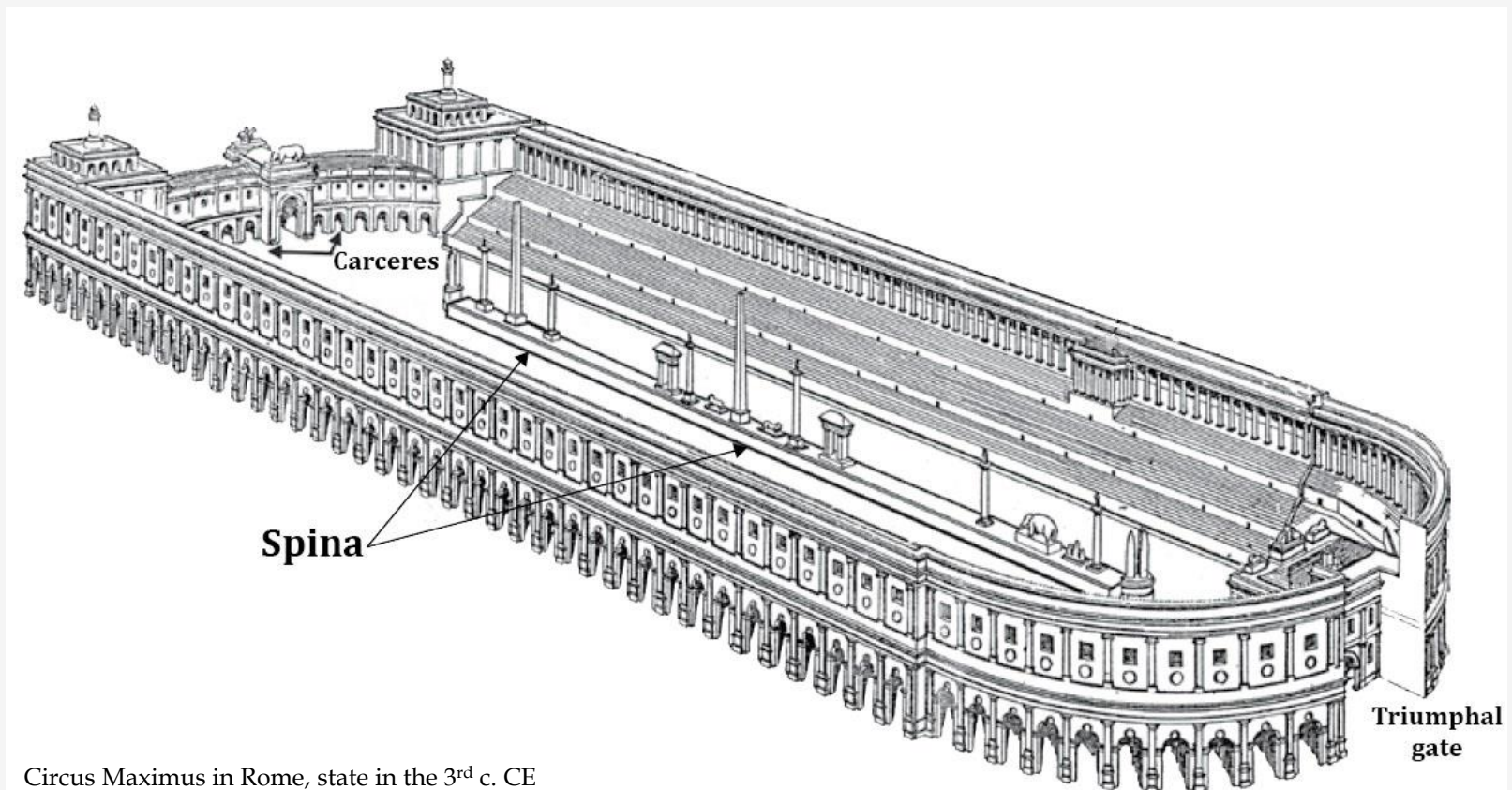

Circus Maximus in Rome, state in the 3rd c. CE

Entertainment structures

Amphitheatre

- Amphi + theatre – “double-theatre”
- Oval in shape with *arena* where gladiatorial fights/games take place
- Earliest stone structure built in Campania, Italy at the end of the 2nd/beginning of the 1st c. BCE
- Built in similar manner as Roman theatres – raised on vaulted substructure



Colosseum in Rome, Flavian (late 1st c. CE)
188x156 m (the largest amphitheatre built)



Amphitheatre in Syracuse, Sicily
90x66 m (more typical)

Sites

Urban theatres and odea

1. Bostra
 2. Scythopolis
 3. Gerasa
 4. Hippos
- ...

Extra-urban (sanctuary) theatres

1. Shuni (Caesarea)
 2. Birketein (Gerasa)
- ...

Hippodromes/Stadia

1. Scythopolis
 2. Gadara
 3. Gerasa
- ...

Amphitheatres

1. Scythopolis
 2. Gerasa
 3. Flavia Neapolis
 4. Eleutheropolis-Beth Guvrin
- ...

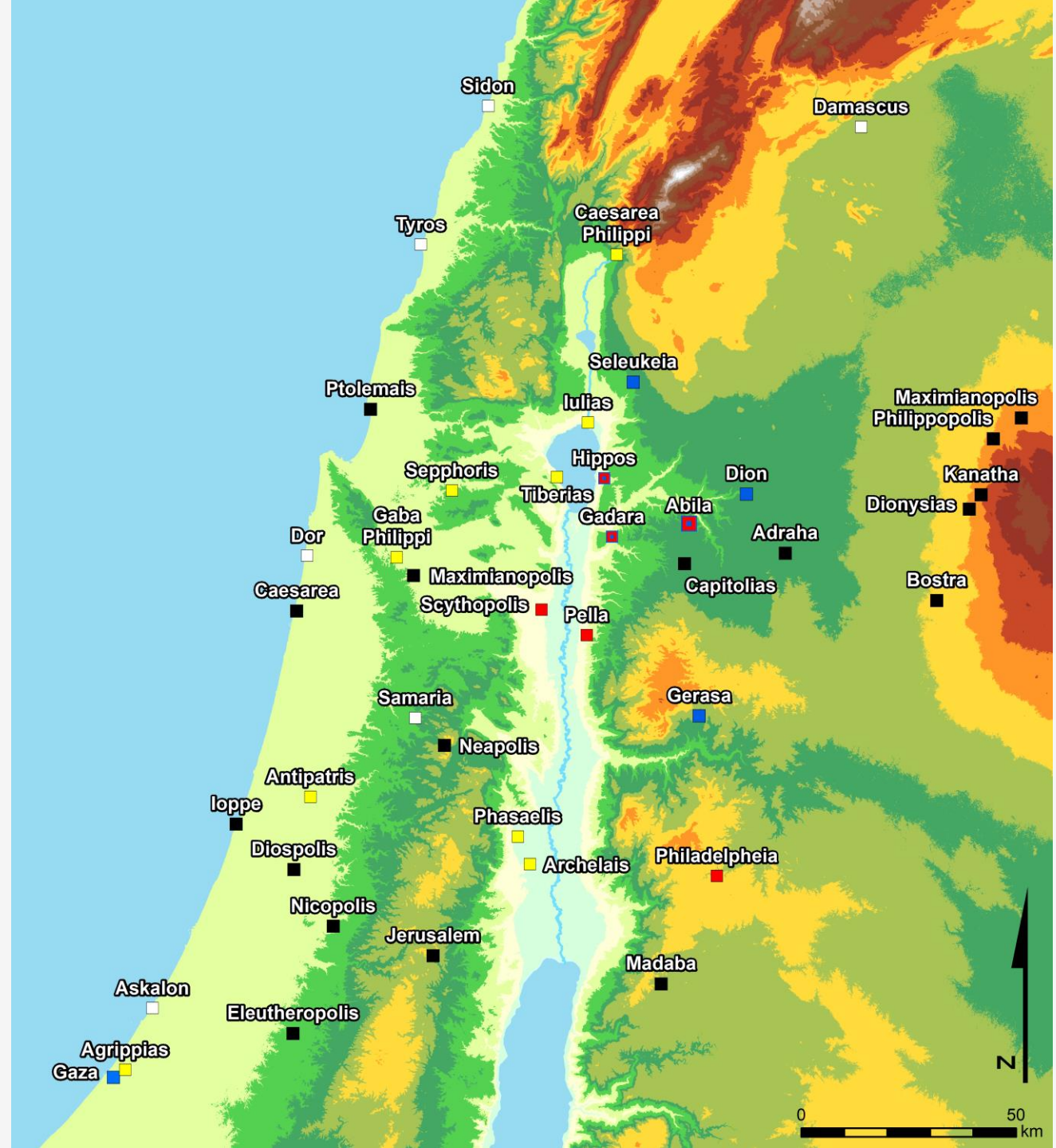

Herodian structures

Caesarea

“About this time it was that **Cesarea Sebaste, which he had built, was finished.** The entire building being accomplished: in the tenth year, the solemnity of it fell into the twenty-eighth year of Herod's reign, and into the hundred and ninety-second olympiad. **There was accordingly a great festival** and most sumptuous preparations made presently, in order to its dedication; for **he had appointed a contention in music, and games to be performed naked.** He had also gotten ready a **great number of those that fight single combats, and of beasts for the like purpose; horse races also, and the most chargeable of such sports and shows as used to be exhibited at Rome, and in other places.** He consecrated this combat to Caesar, and ordered it to be celebrated every fifth year. He also sent all sorts of ornaments for it out of his own furniture, that it might want nothing to make it decent; nay, Julia, Caesar's wife, sent a great part of her most valuable furniture [from Rome], insomuch that he had no want of any thing. The sum of them all was estimated at five hundred talents. **Now when a great multitude was come to that city to see the shows, as well as the ambassadors whom other people sent, on account of the benefits they had received from Herod, he entertained them all in the public inns, and at public tables, and with perpetual feasts;** this solemnity having in the day time the diversions of the fights...”

AJ 16.136-140

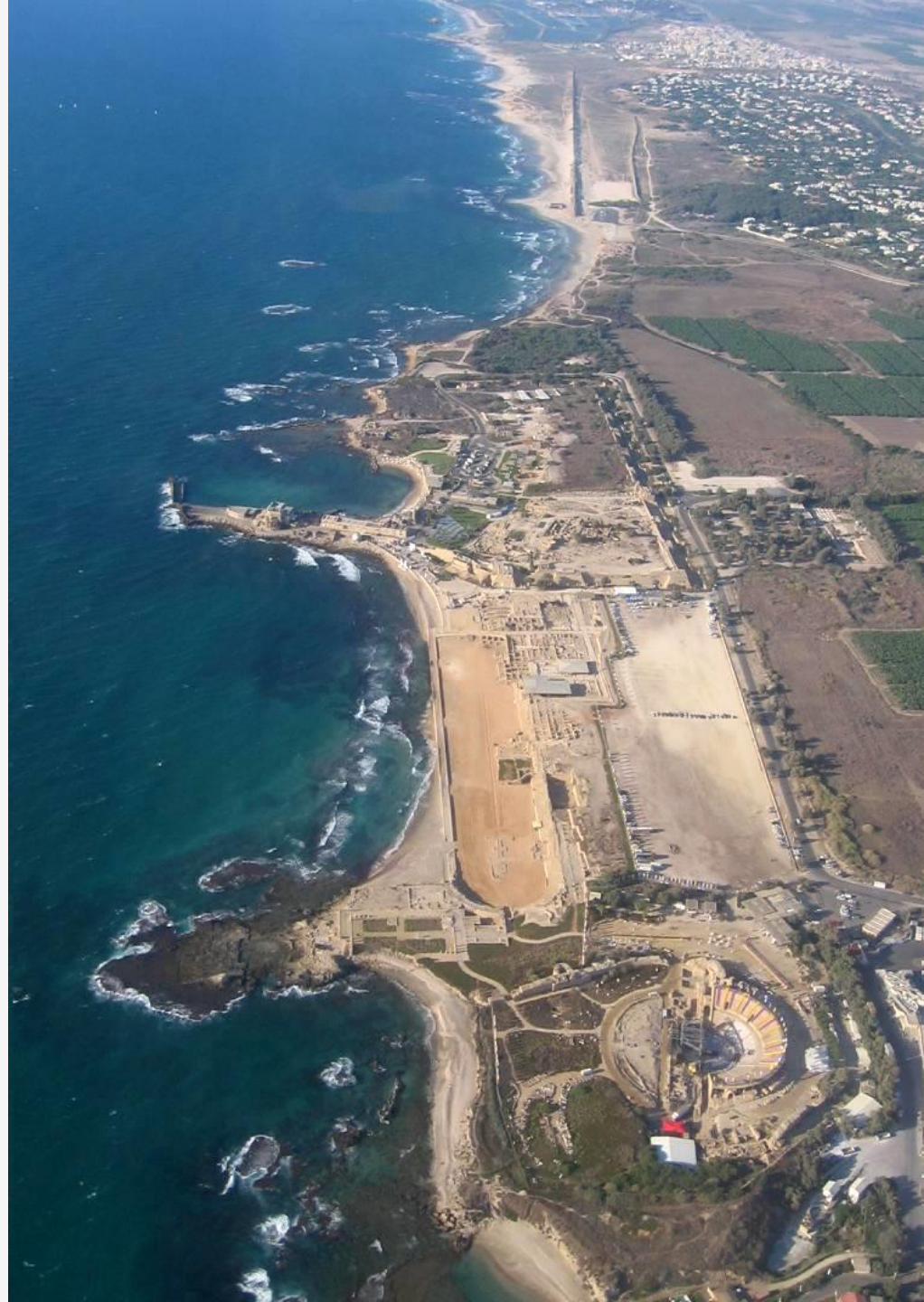

Herodian structures

Caesarea

- Theater + “hippodrome-stadium” (called amphiteater in Josephus)
- Hippodrome and palace form one complex → Hellenistic influence combining palatial structure with an entertainment structure – hippodrome provides place for direct royal communication with the masses
- This is reflected later in the Imperial palaces in Rome and Constantinople
- The theater does not conform to the street grid – it blocks a cardo that would otherwise reach a southern gate
- The theater and southern part of the city were probably developed in the final days of city construction
- Considerations: proximity to the palace, orientation to the sea (winds, light)

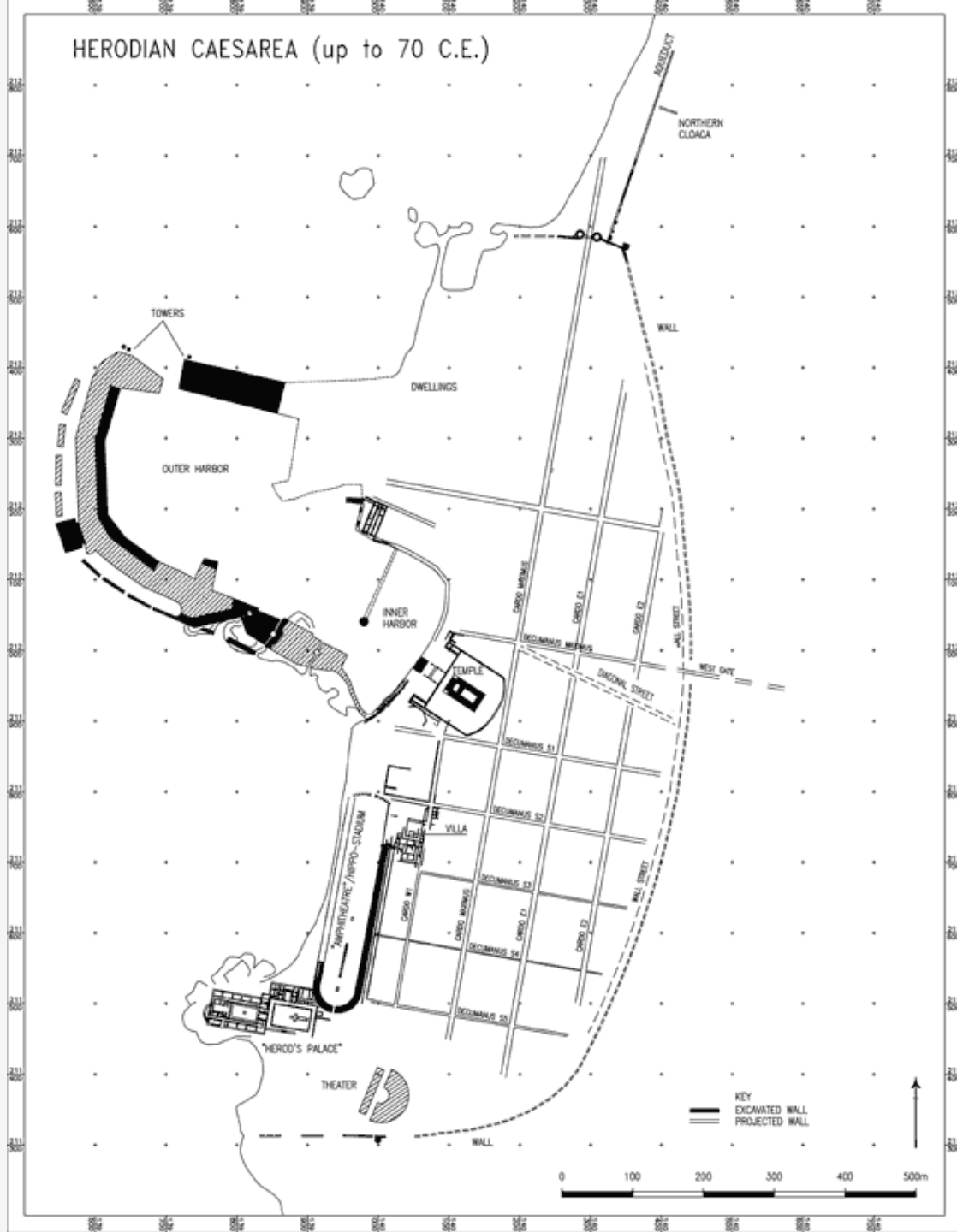

Herodian structures

Caesarea

- Hippodrome and palace form one complex → Hellenistic influence combining palatial structure with an entertainment structure – hippodrome provides place for direct royal representation to the masses
- This is reflected later in the Imperial palaces in Rome and Constantinople

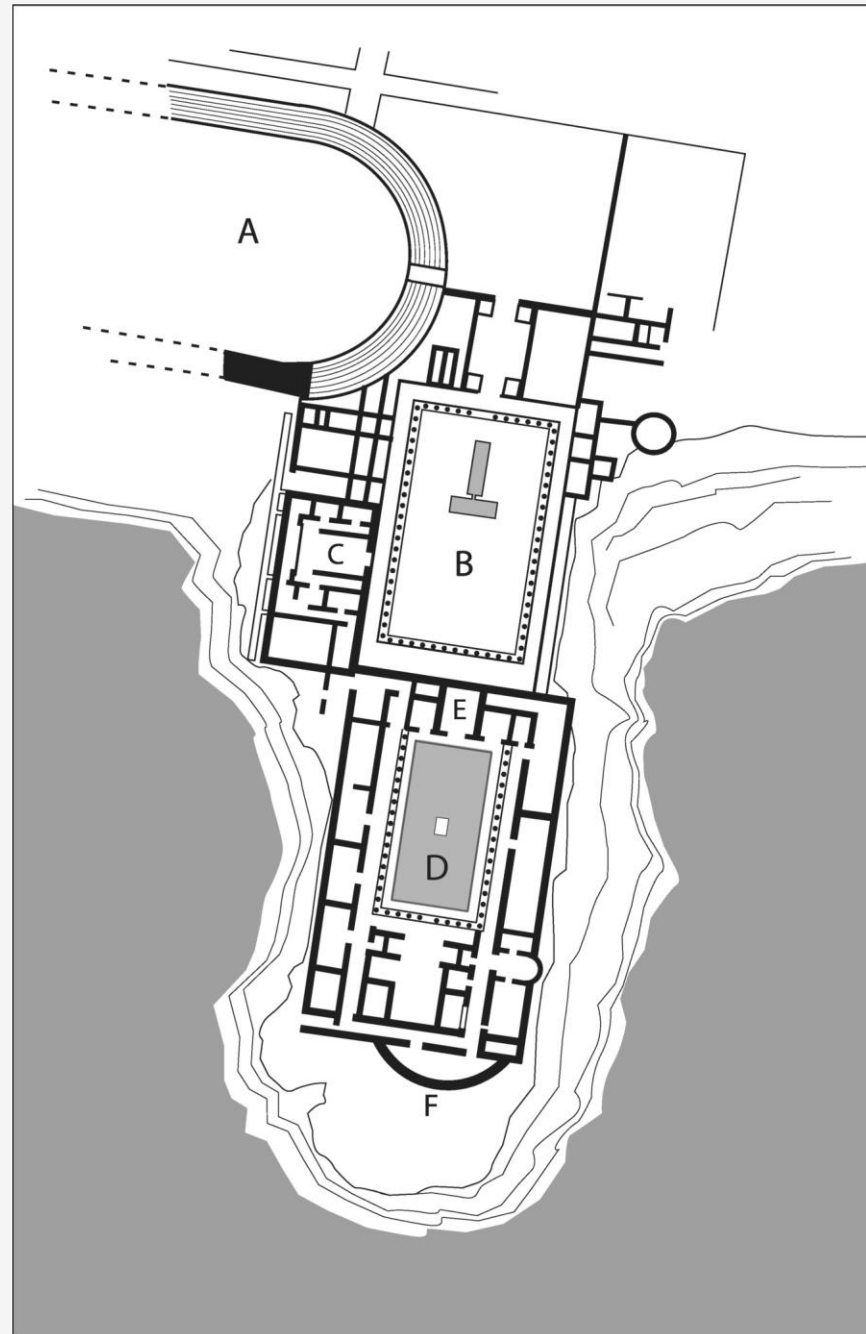

- A Stadium / hippodrome
- B Upper palace
- C Audience Hall (?)
- D Lower palace with pool and peristyle
- E Triclinium
- F Apsidal balcony / belvedere



0 20 40 m



Herodian structures

Caesarea

- Theater
- Facing the sea, partly hewn on the slopes, upper part of cavea (*summa cavea*) built on vaults
- $\text{Ø} = 90 \text{ m}$
- 3,500-4,000 people

- Orchestra re-built 50-75 CE

- Curved *scaenae frons* with central rectangular niche and flanking semi-circular niches
- The design of the *scaenae frons* and *cavea* suggest rather Hellenistic models than Roman

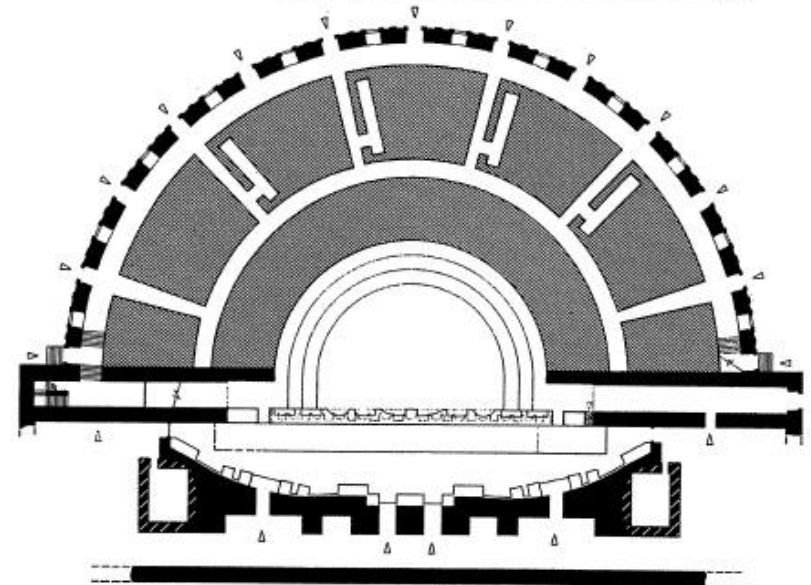
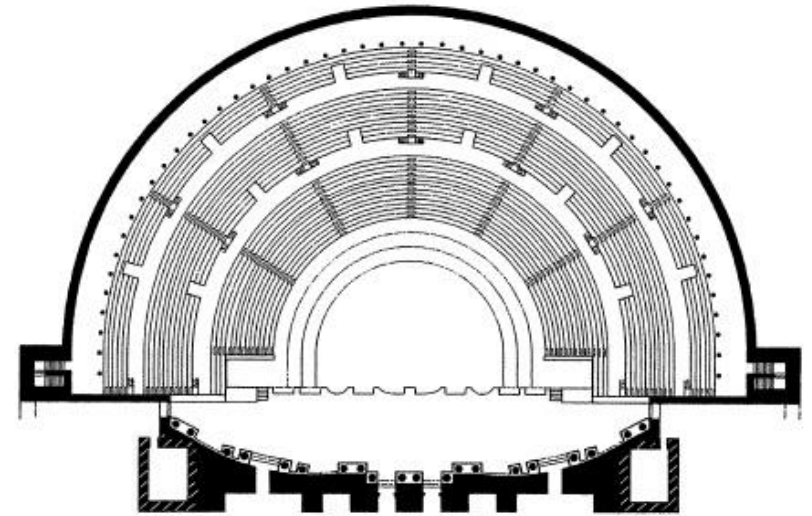
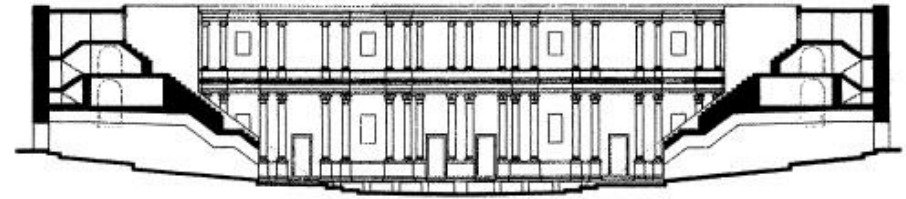

Herodian structures

Caesarea

- Theater – partially rebuilt, used for concerts nowadays



Herodian structures

Caesarea

- Hippodrome
- Partially hewn into the bedrock
- Vaulted structure built of *kurkar* (local sandstone) and concrete
- 310x66 m
- Up to 10,000 people

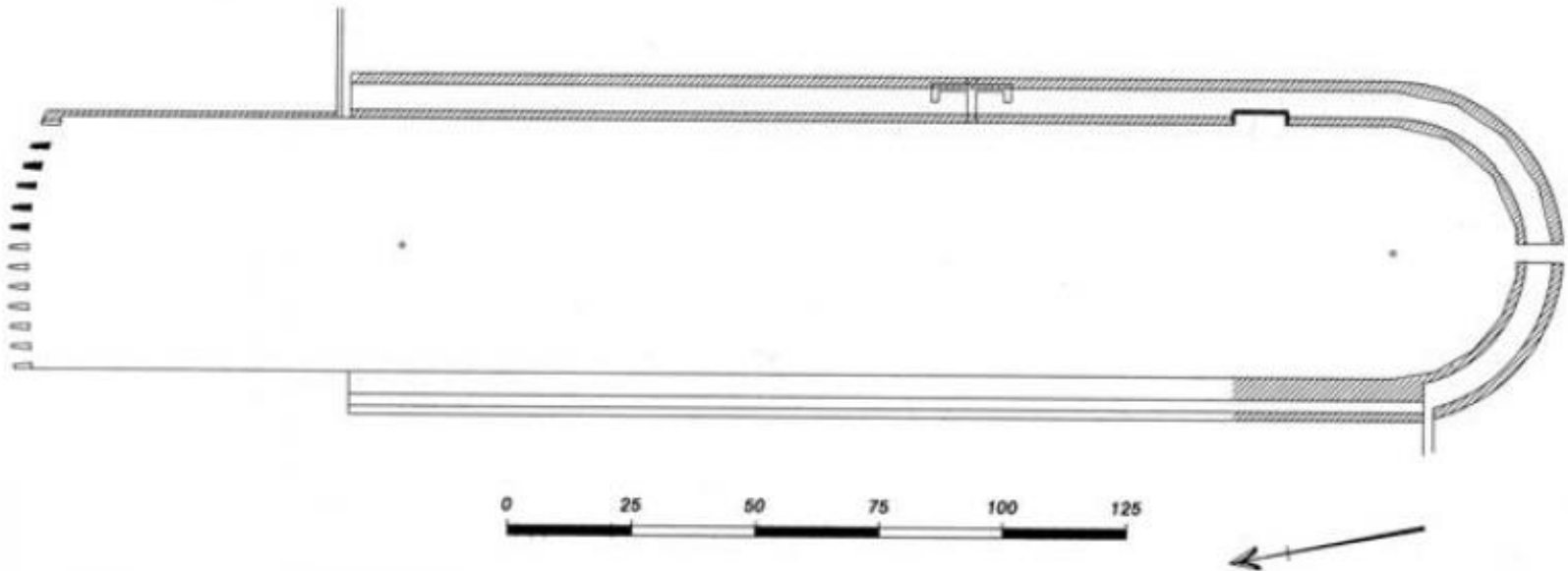
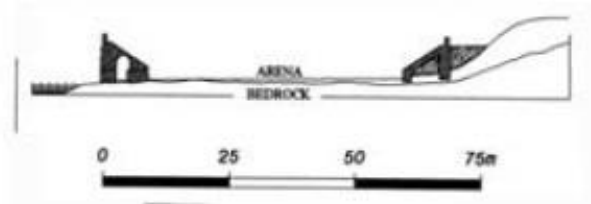

Herodian structures

Caesarea

- Hippodrome



Herodian structures

Caesarea

- Hippodrome
- Outer face of the building and vaulted construction



Herodian structures

Jericho

- Tell e-Samarat, ca. 1.5 km north of the Herodian palaces
- Rather unique combination of a hippodrome/stadium with a theatrical seatings and a peristyle court
- “Multi-purpose entertainment structure”
- Ca. 92x70 m artificially raised mound with the *cavea* and peristyle court
- Ca. 3,000 people
- 315x82 rectangular hippodrom/stadium attached to the south
- Unclear if surrounded by a colonnade
- All built of mudbrick with plaster and stucco decoration



Herodian structures

Jericho

- “Multi-purpose entertainment structure“



Herodian structures

Jericho

- “Multi-purpose entertainment structure“

“...Salome and Alexas gathered the soldiery together in the *amphitheater* at Jericho...” AJ 17.194

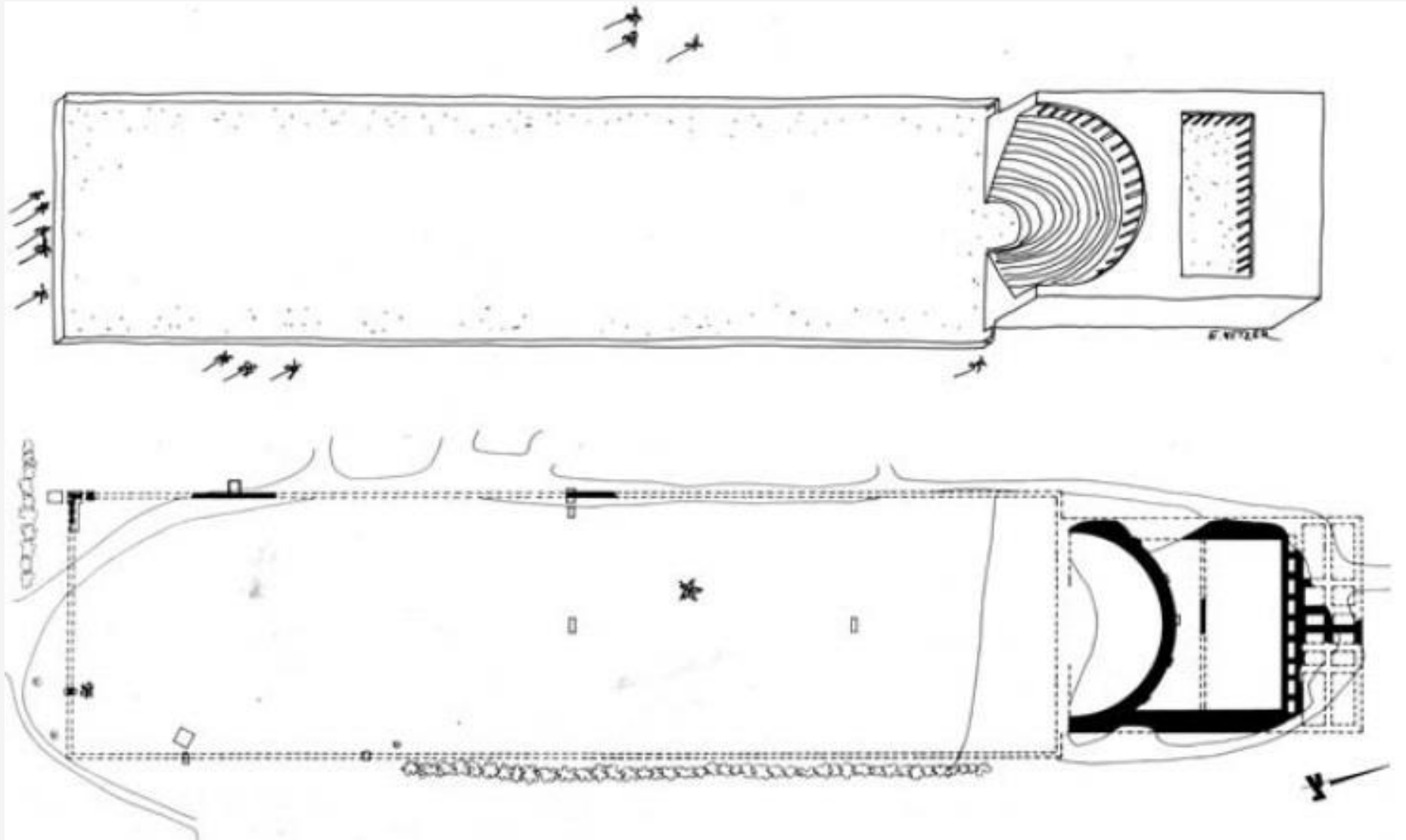

Hippos

- Two structures: odeum and theater
- Odeum is built close to the civic centre – the fact that it is not directly in the civic centre suggests that this part of the city was already developed before conception of an odeum
- Theater on a natural slope on the saddle – part of the city extension
- Both dated to the end of the 1st (odeum)/beginning of the 2nd (theatre) c. CE

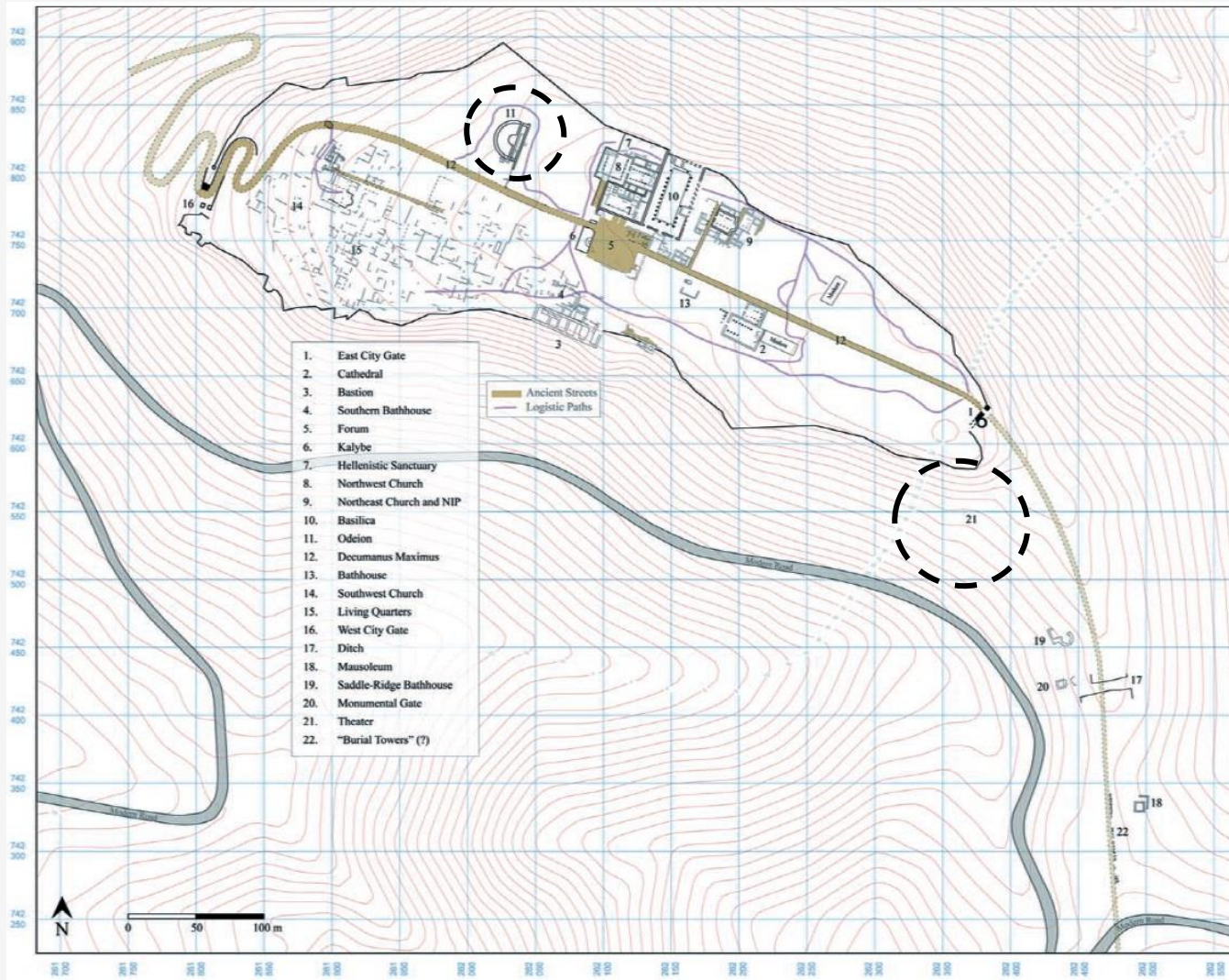

Hippos

Odeum

- Western half of the city, ca. 21 m north of the decumanus, presumably on one of the cardines
- Basalt foundation and base with limestone upperstructure
- $\varnothing = 27$ m
- Ca. 500 people



Hippos

Odeum

- Ceased to be used already before the earthquake of 363 CE
- Note the decorative moulding in the *aditus maximus* (main passageway to the orchestra)

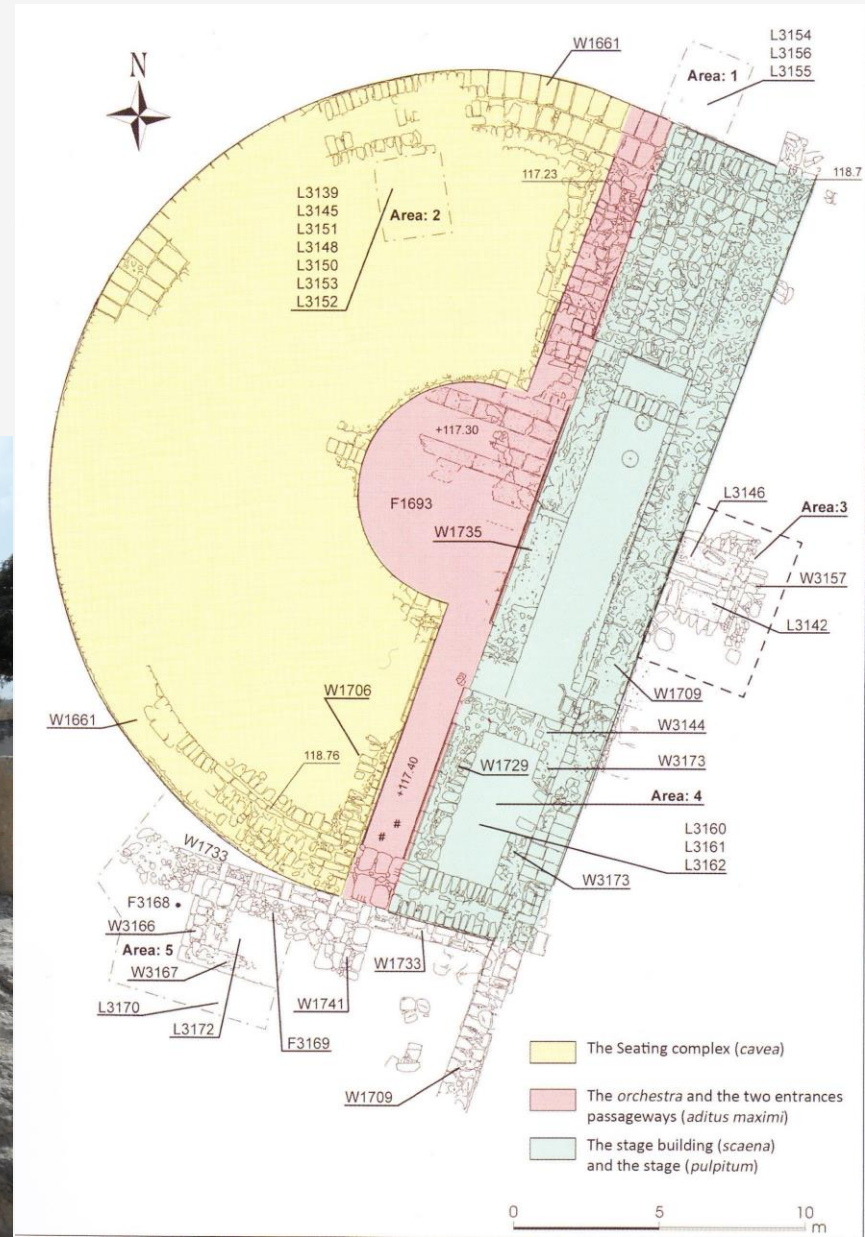

Hippos

Odeum

- Suggested reconstruction



Hippos

Odeum

- Suggested reconstruction

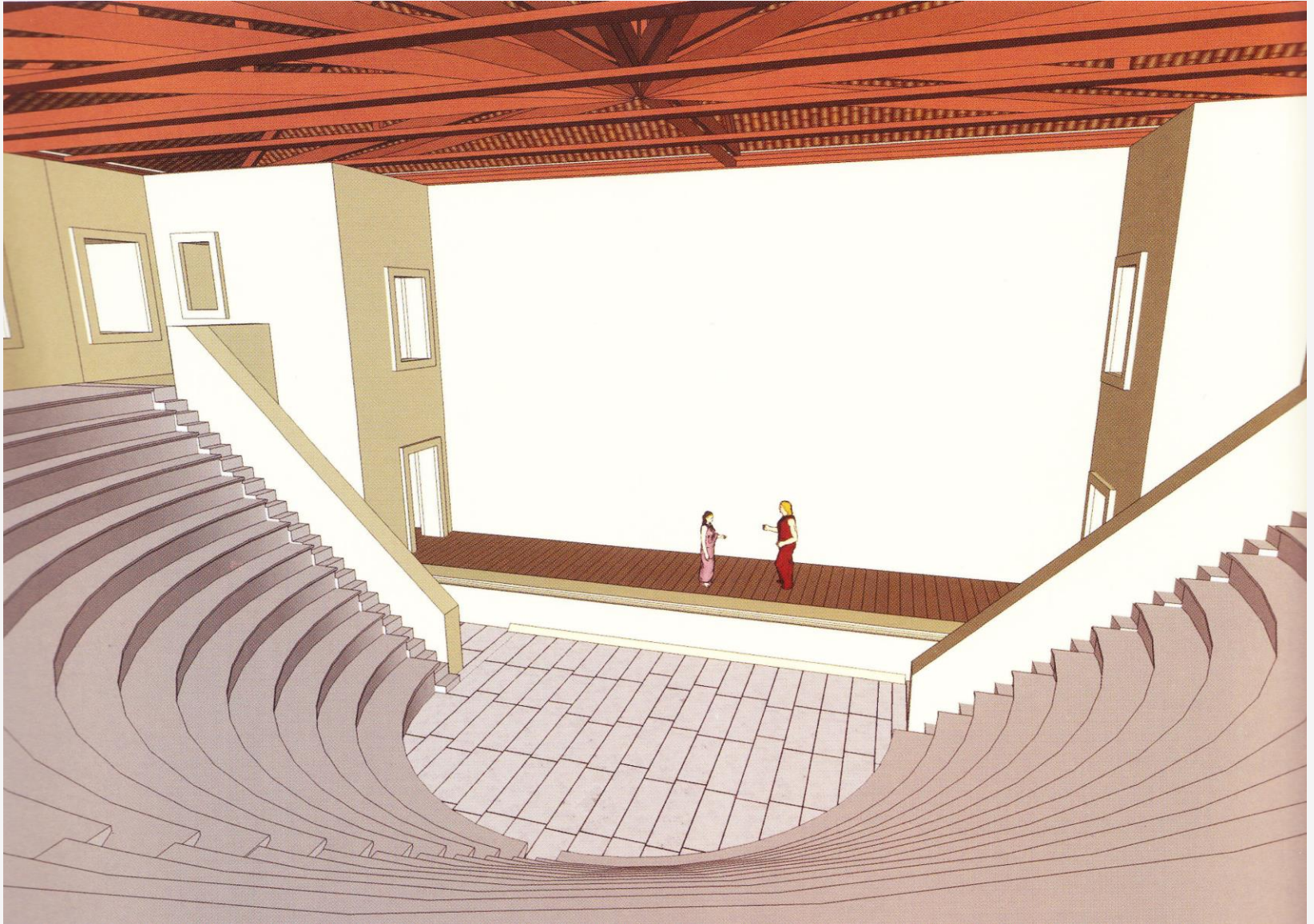

Hippos

Theatre

- Identified only in 2017, limited excavations since then
- Rather small compared to other cites ($\varnothing = \text{ca. } 35 \text{ m}$)



Scythopolis

- Two theatres, hippodrome → amphitheatre
- Odeum/bouleuterion part of the Caesareum complex
- Southern theatre built in the early 1st c. CE immediately south of the agora
- Northern theatre built on the lower slopes of the main tell above intersection of the main colonnaded streets in the late 2nd c. CE (Severan period)
- Both theatres and odeum help to define monumental civic centre
- Hippodrome built ca. 300 m south of the agora in the Severan period as well
- At that time this part of town was sparsely settled – enough space for its construction

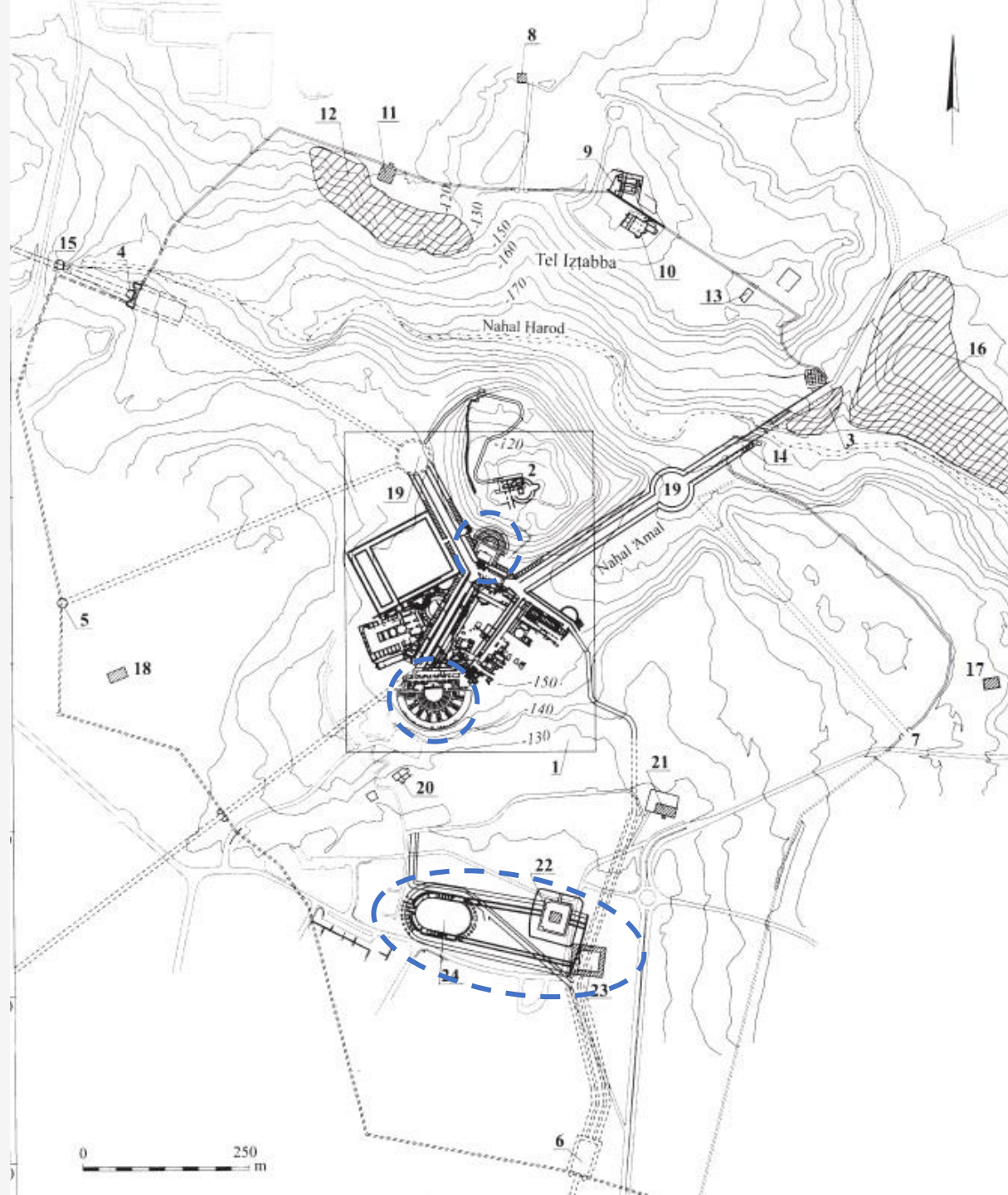

Scythopolis

Southern theatre

- Re-built in the Flavian period
- Massive reconstruction and enlargement in the Severan period
- Foundations and *cavea* built of basalt, *scaena*, orchestra and seats of hard limestone
- One of the small agora temples was incorporated to the north-eastern corner of the theatre
- Partially built on slope
- $\varnothing = 82$ m
- Up to 6,000 people

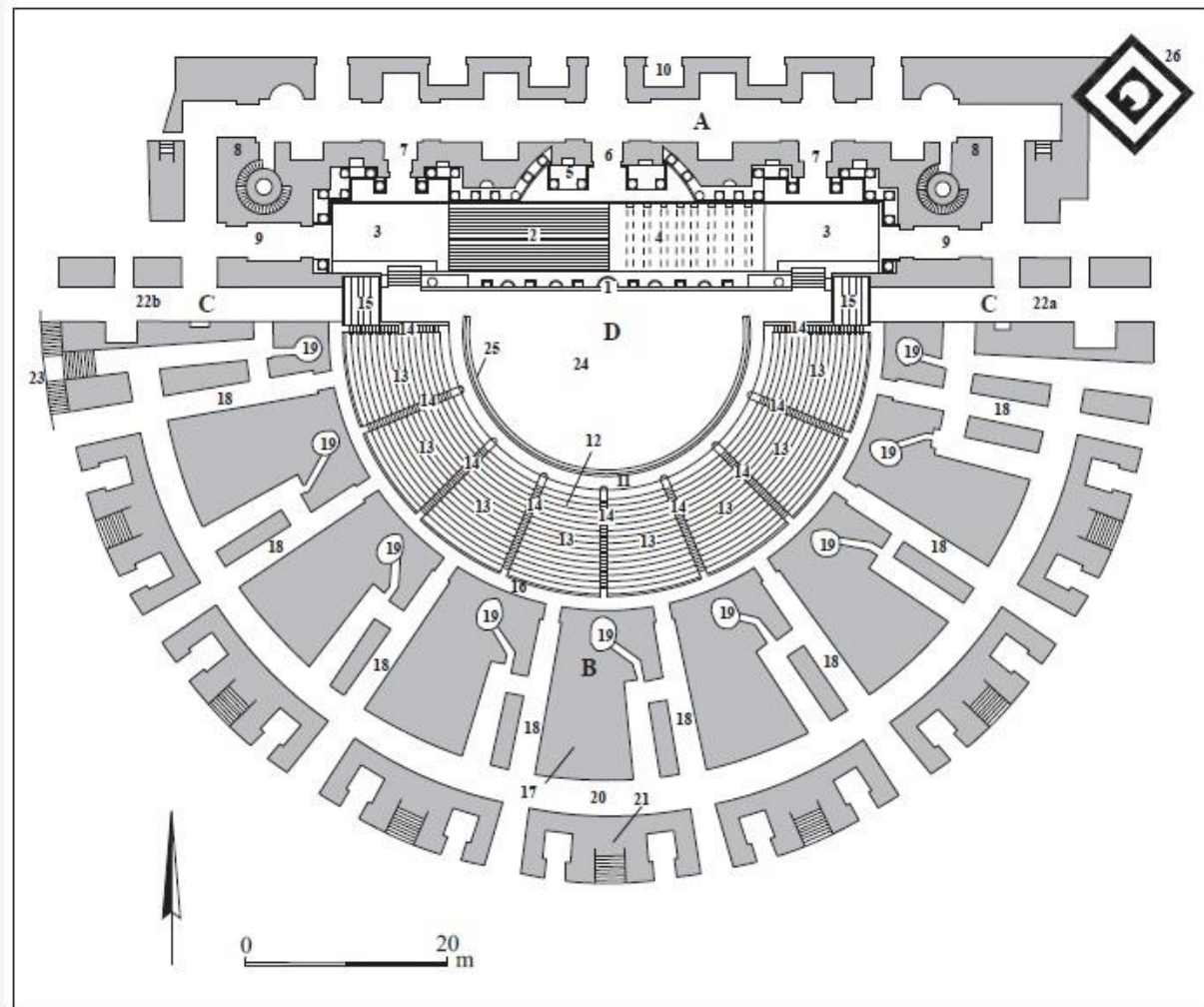

A. Scaena

1. Proscenium
2. Pulpitum
3. Pulpitum Flanks
4. Hyposcaenium
5. Scaenae Frons
6. Valvae Regiae
7. Hospitalia
8. Versurae
9. Itinera Versurarum
10. Postscaenium

B. Cavea

11. Balteus
12. Ima Cavea
13. Cunei
14. Scalaria
15. Tribunalia
16. Praeinctio
17. Media Cavea
18. Vomitoria
19. Acoustic Cells
20. Ambulacrum
21. Summa Cavea

C. Aditus Maximi

- 22a. Eastern Aditus Maximus
- 22b. Western Aditus Maximus
23. Western Staircase

D. Orchestra

24. Orchestra
25. Bisellia
26. Forum Temple II

Scythopolis

Southern theatre



Scythopolis

Southern theatre

- *Cavea* – the basalt was used for vaulted construction of the theater, while limestone for the seats and stairs



Scythopolis

Southern theatre

- Partially reconstructed *scaenae frons* and eastern *aditus maximus*
- Note the monolithic granite columns with Corinthian capitals
- Additional fragments of marble decoration and statues decorating the *scaenae frons* were found
- Floral frieze with animal and human figures



Scythopolis

Hippodrome - amphitheatre

- Built ca. second half of the 2nd c. CE
- Partially excavated, ca. 260 m+ in length
- Up to 12,000 spectators
- Western part turned into amphitheater (102x68 m) in the mid-4th c. CE

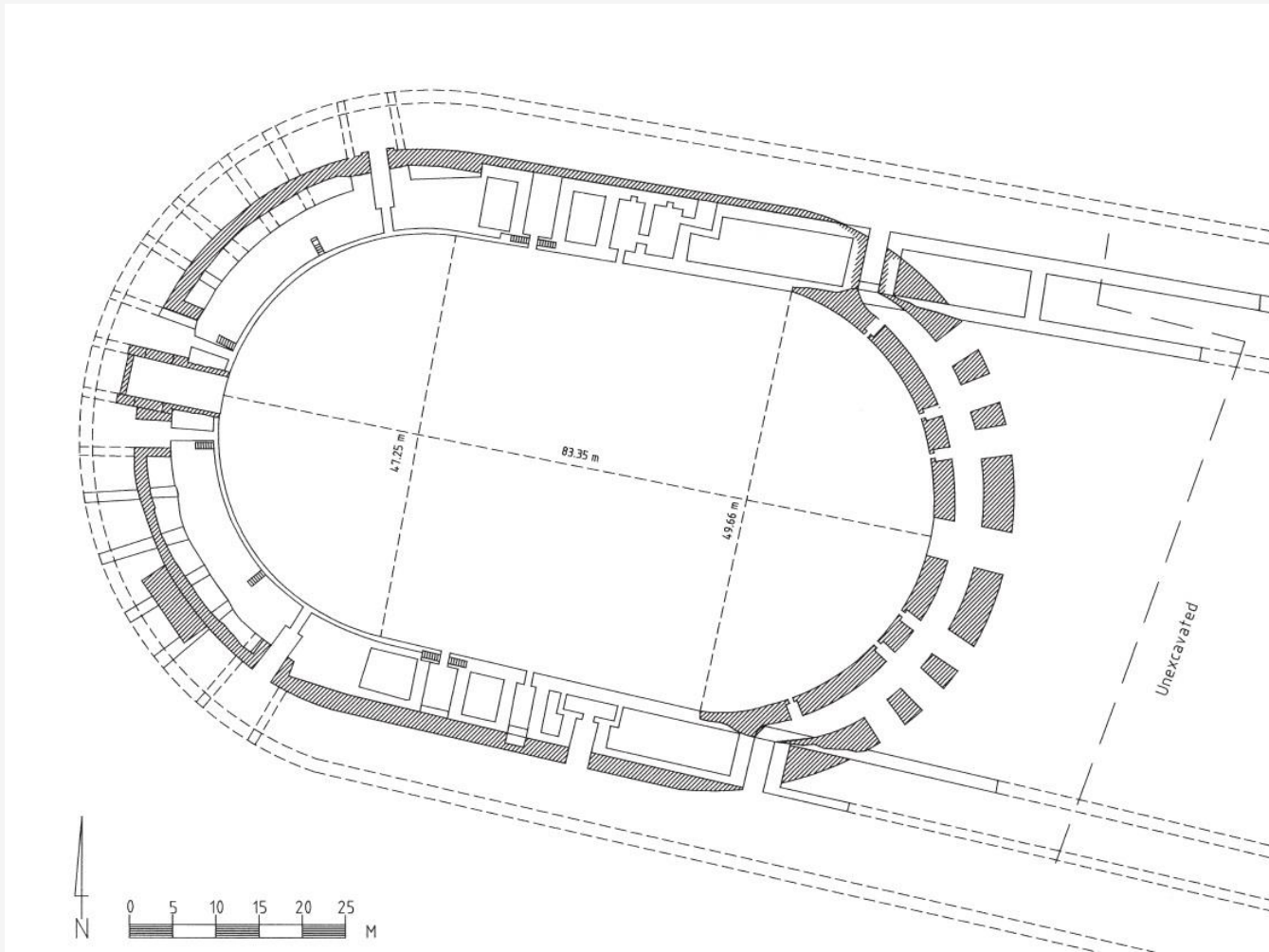

Gerasa

- Two theatres + hippodrome-amphitheatre
- Southern theatre (older) might be connected to religious festivals at the temple of Zeus
- Northern theatre is part of a new civic compound in the northern part of the city extending on both sides of the northern decumanus (+agora, basilica)
- The hippodrome is built along the southern access road to the city

- Southern theatre ca. 90 CE
- Northern theatre second half of the 2nd c. CE (Antonine)
- Hippodrome second half of the 2nd c. CE (Antonine)

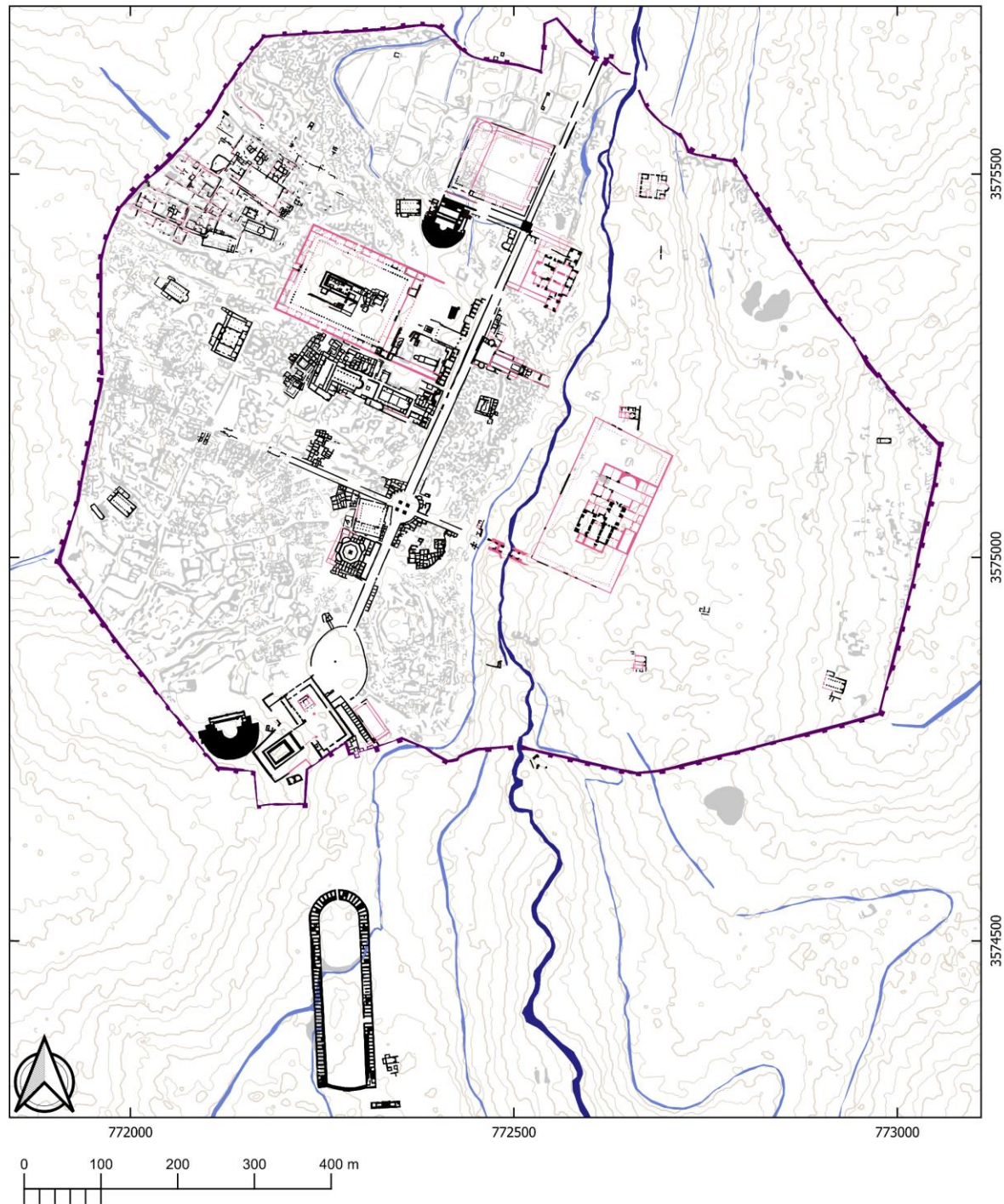

Gerasa

Northern theater

- Rather small, $\varnothing = 44$ m
- Ca. 1,600 spectators



Gerasa

Northern theater

- Reconstruction of the northern decumanus, with propylaeum of the theater

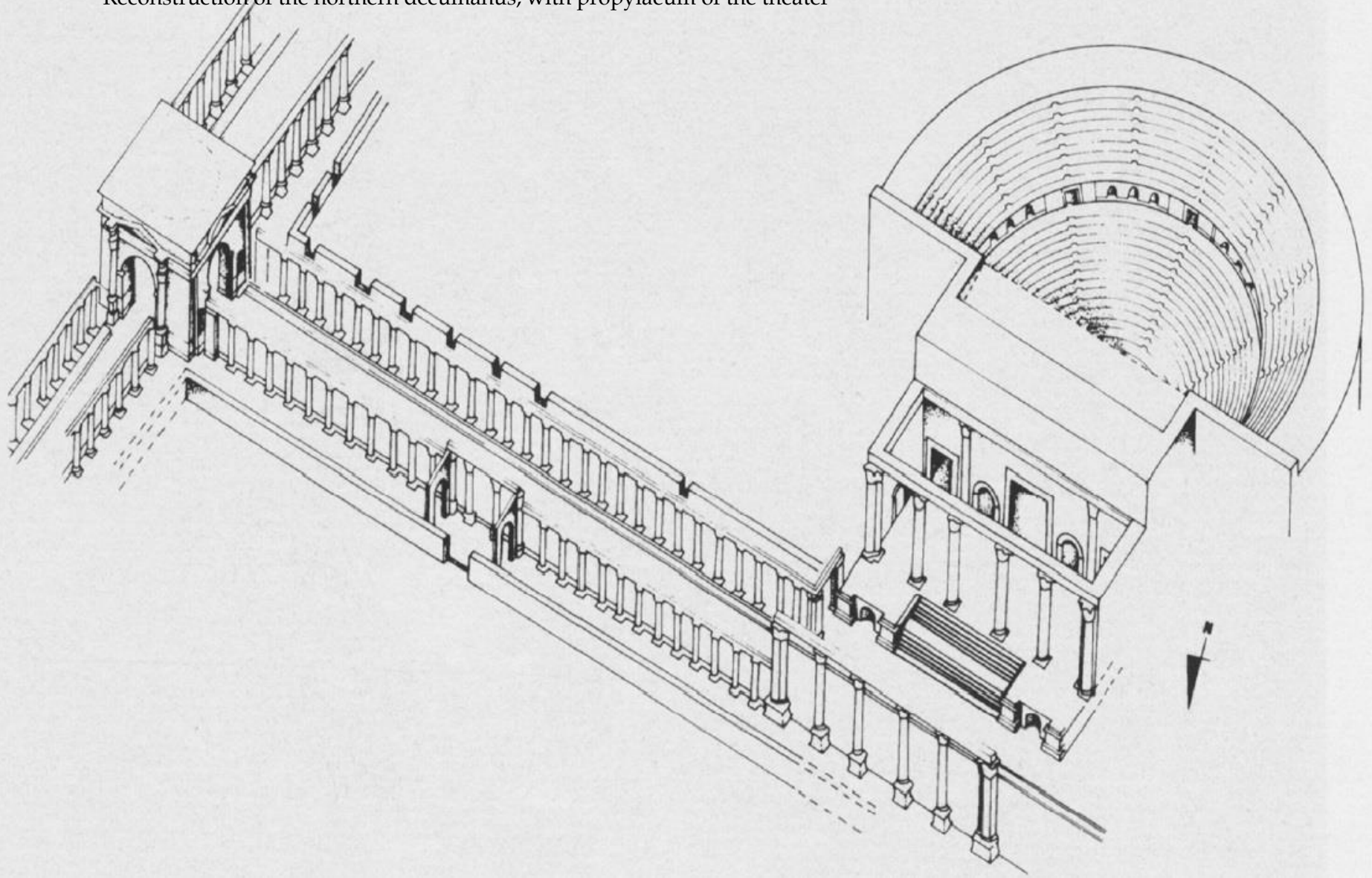

Gerasa

Northern theater

- Propylaea – northern theater left, agora right



Gerasa

Hippodrome - amphitheatre

- Built over and earlier necropolis extending along the southern access road to the city



Gerasa

Hippodrome - amphitheatre

- Ca. 265x78 m
- Rooms on the ground floor open to the outside – might have been used as shops/workshops – note they line perfectly with the (earlier) western passage of the Hadrian's arch
- Amphitheater was inserted apparently at the later part of the 4th c. CE (as the southern part of the hippodrome started to be quarried for stone at that time)

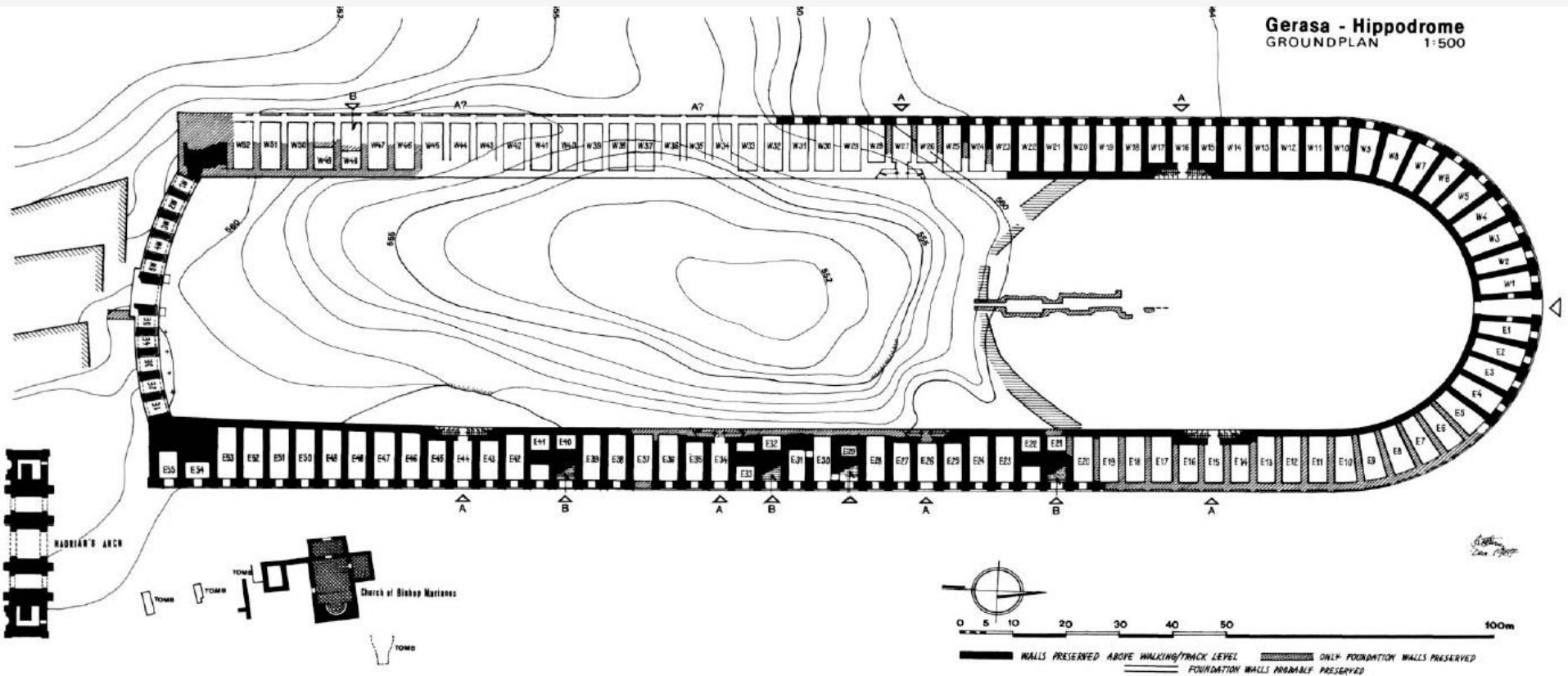

Gerasa

Hippodrome - amphitheatre

- Carceres

CARCERES NORTH FACADE - 1:100
RECONSTRUCTION

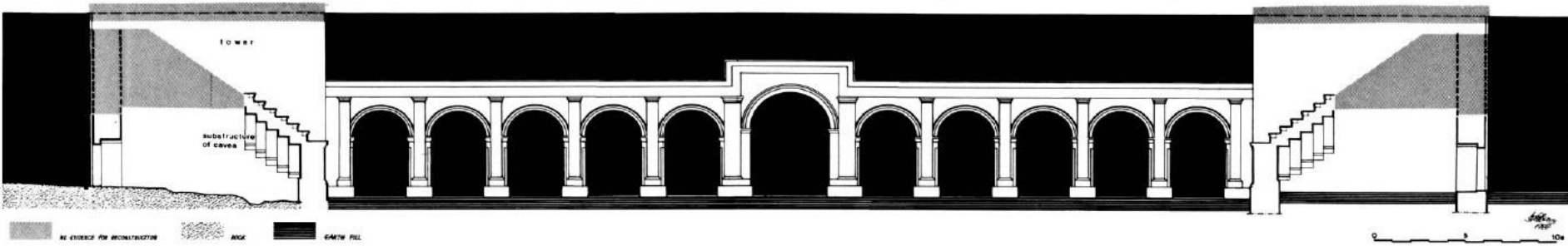

Extra-urban sites

Shuni/Shumi - Maioumas

- A sanctuary-theater at the foot of the Carmel, ca. 6 km north-east of Caesarea
- Above aqueduct bringing water from En Tzur to the city

The Aqueducts to Caesarea

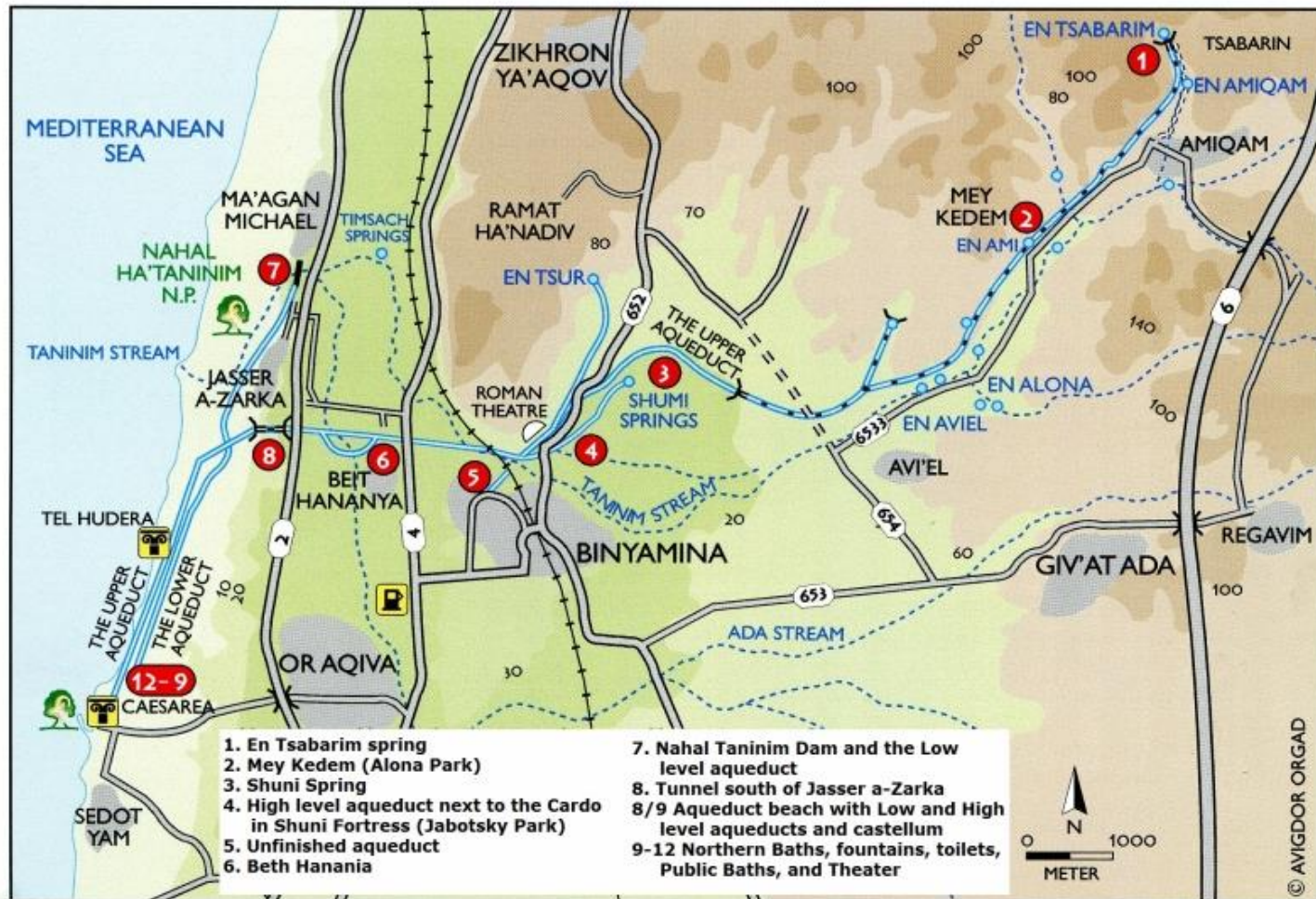

Extra-urban sites

Shuni/Shumi - Maioumas

- Maiouma was a nocturnal water festival taking place in May (according to some later sources once every three years)
- The festival apparently included naked swimming of the actors in the theater and other orgiastic festivities
- Apparently celebrated well into the Byzantine period
- Fragment of Asclepius' statue might indicate that place served also as a healing centre (especially since the spring En Tzur itself was used in such capacity)



Extra-urban sites

Shuni/Shumi - Maioumas

- The theater was overlaid by later Medieval and Ottoman houses
- Built on natural slope
- $\varnothing = \text{ca. } 45 \text{ m}$, orchestra 13 m
- Late 2nd/early 3rd c. CE (Severan)
- Partially restored and used for venues nowadays



73. Shumi, the theatre, aerial photograph at the start of excavations.

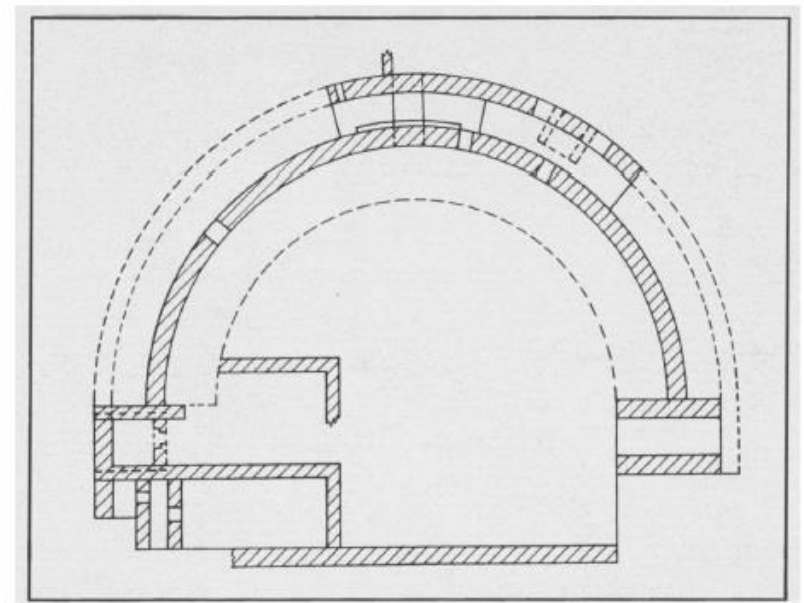

74. Shumi, the theatre, schematic plan.

Extra-urban sites

Shuni/Shumi - Maioumas

- Orchestra, partially restored *cavea* and northern *aditus maximus*



Extra-urban sites

Birketein

- Lit. "Two pools"
- Small theater sanctuary with a large double pool ca. 1.6 km north of Gerasa (1)
- Also connected with Maiouma festival
- Birketein is one of the main sources of water for the city

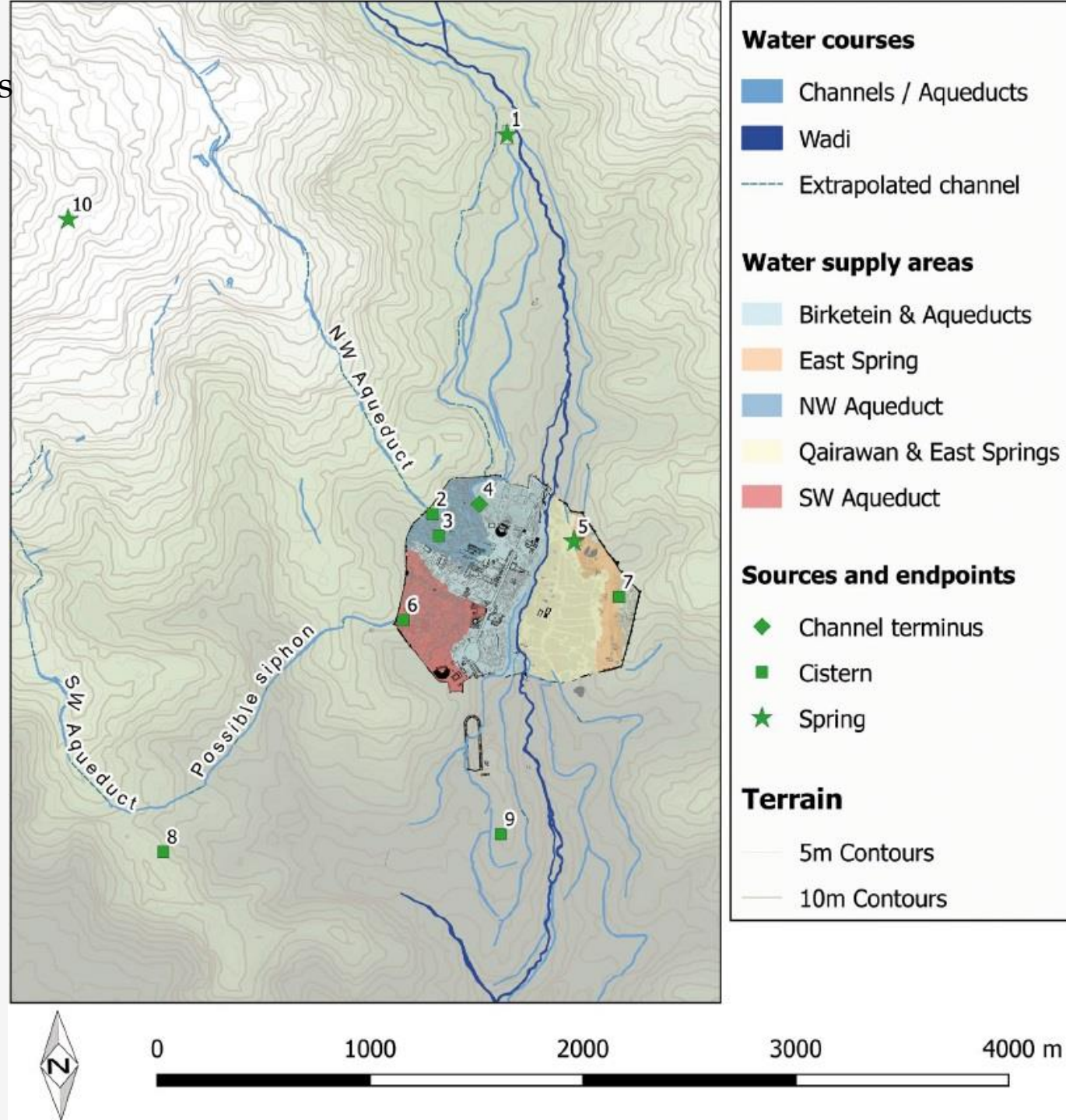

Extra-urban sites

Birketein

- Lit. “Two pools”
- Small theater sanctuary with a large double pool ca. 1.6 km north of Gerasa
- Also connected with Maiouma festival

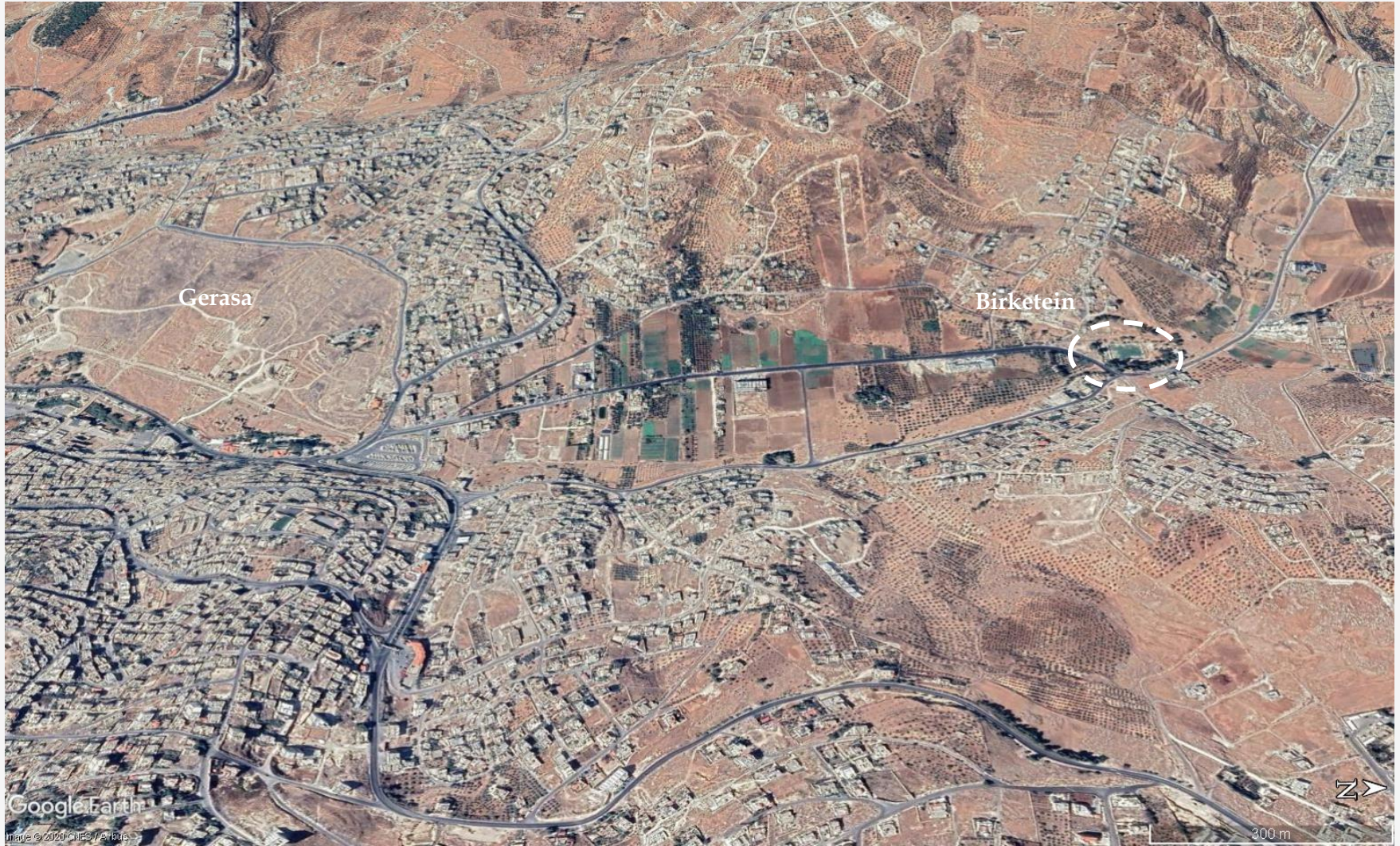

Extra-urban sites

Birketein

- The double pool is 43.5x88.5 m and surrounded by a colonnade
- Theater is rather small ($\varnothing = 28$ m, ca. 1,000 spectators)
- The *scaena* might have been low so as to facilitate overview of the pool during the festivities

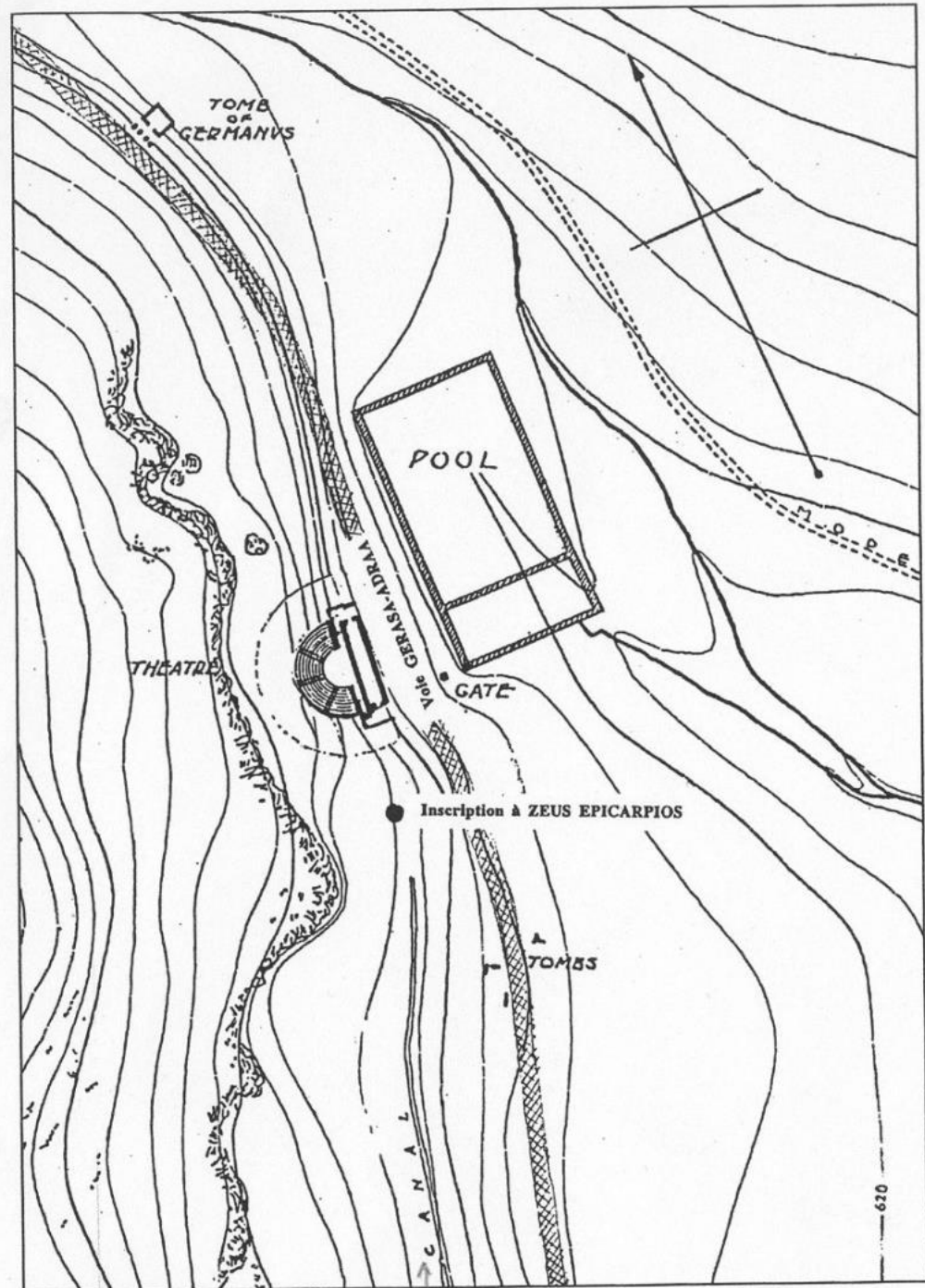
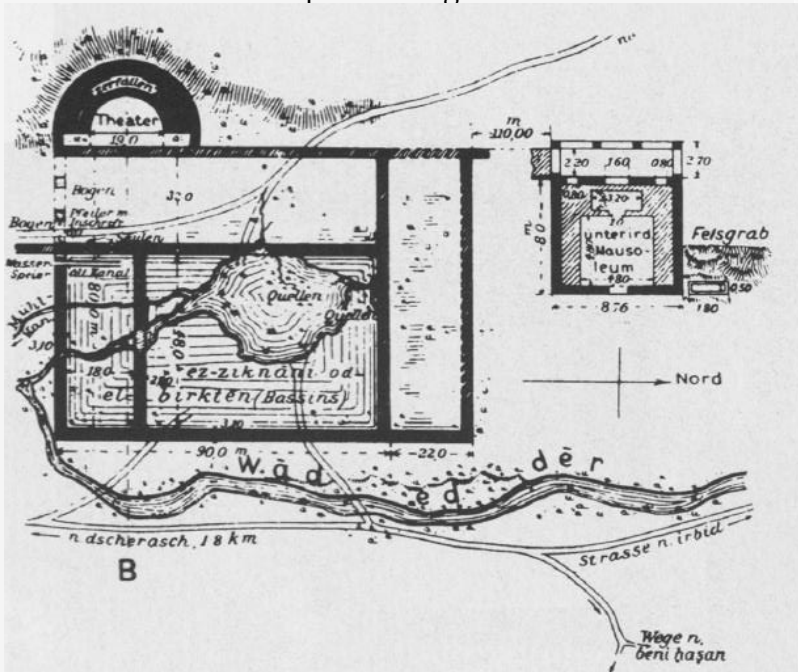

Extra-urban sites

Birketein

- On natural slope
- The *scaena* might have been low so as to facilitate overview of the pool during the festivities



Extra-urban sites

Hammat Gader

- “Suburb” of Gadara in the valley of Yarmouk/Hieromyces, ca. 3 km north from the city
- Hot springs



Extra-urban sites

Hammat Gader

- Numismatic evidence suggest that *naumachia* (i.e. water games, often simulating naval battles) were held in Gadara
- Galleys and dolphins appear often on the coinage of the 2nd-early 3rd c. CE (circumstantial evidence however)
- Hammat Gader (i.e. the river flowing through the place) is one plausible place for such spectacle



36

Ob. Bust of Marcus Aurelius r., laureate
Rev. Galley sailing l., navigator at stern and
standard-bearer in front
ΓΑΔΑΡΕΩΝ ΝΑΥΜΑ
ΔΚΣ (year 224 = 160/1 CE)
AE medallion, Gadara



66

Ob. Draped and cuirassed bust of
Commodus, r., laureate
Rev. Galley sailing l., navigator at
stern and a look-out on prow
ΠΟΜΠΗ ΓΑΔΑΡΕΩΝ
ΕΤ ΒΜΣ (year 242 = 178/9 CE)
AE medallion, Gadara



Extra-urban sites

Hammat Gader

- A small sub-urban settlement (6) developed around the hot springs between 1st-3rd c. CE
- Colonnaded streets (3), large bathhouse (1, spa-medicinal), theater (2), synagogue (7)
- Theater probably was not the place where *naumachia* were held; no. 8 indicates a row of ornamental basalt seats overlooking the spring Ain el-Jarab and its pool (9)

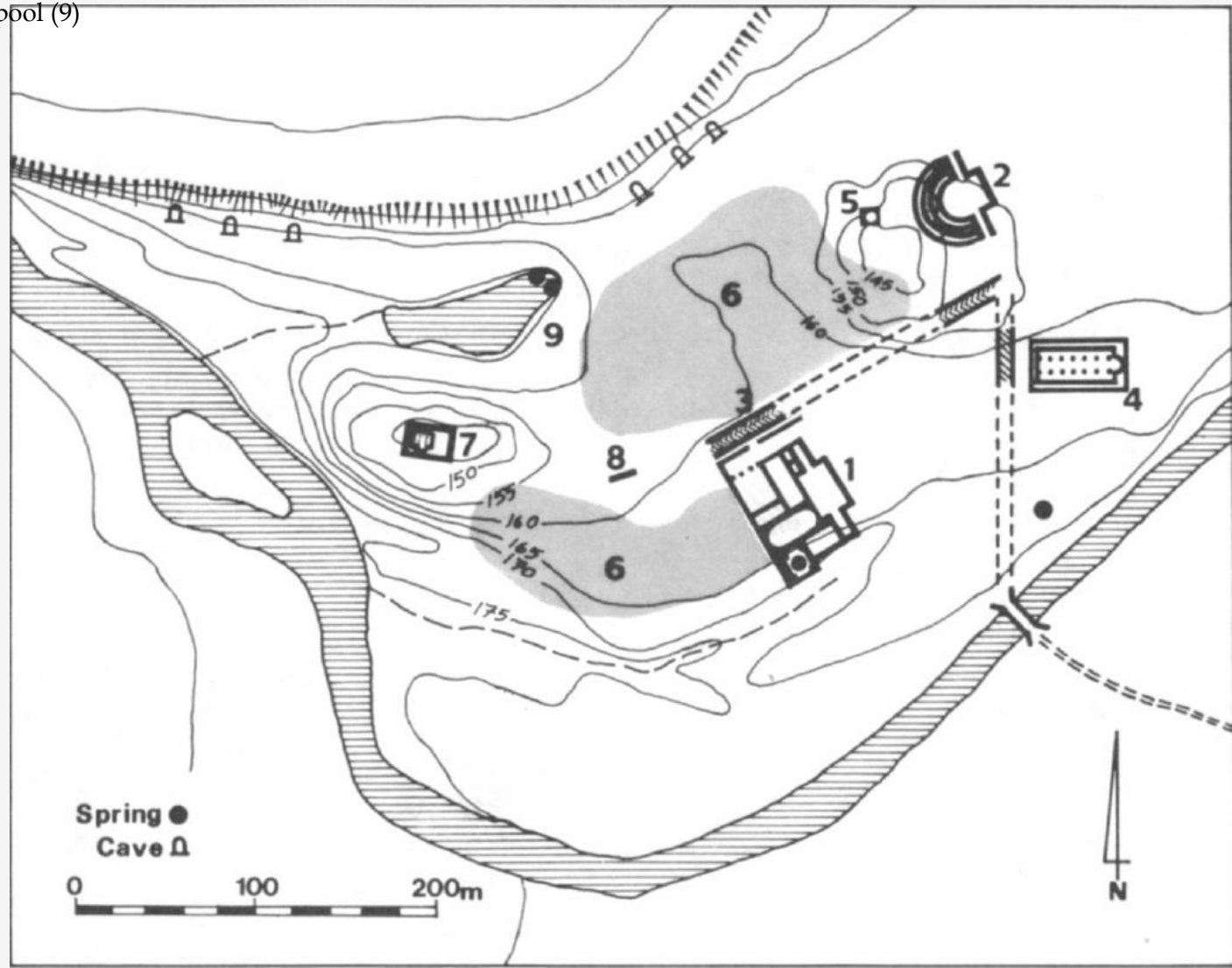

Extra-urban sites

Hammat Gader

- The seats resembles seats for city notables and guests of honour commonly found in the theaters
- It might be that there was an artificial pool around Ain el-Jarab where *naumachia* were held, with seatings for spectators on the elevation to the south where the basalt seats were found



- Seats for notables in the theatre of Bostra



Romanization?

Amphitheatres

- Caesarea (not excavated, 2nd c.?)
- Eleutheropolis-Beth Guvrin (Severan)
- Legio/Maximianopolis (in Galilee, 2nd c.)
- Bostra (2nd c.)

Re-built hippodromes:

- Scythopolis (4th c.)
 - Neapolis (mid-3rd c.?)
 - Gerasa (4th c.)
- Legio and Bostra held a legionary camp, Caesarea was a seat of government (→ strong Roman presence)
 - Eleutheropolis and Neapolis were Roman *coloniae* - likely composed of Roman veterans (definitely in case of Neapolis)
 - Only Gerasa and Scythopolis are “local” cities

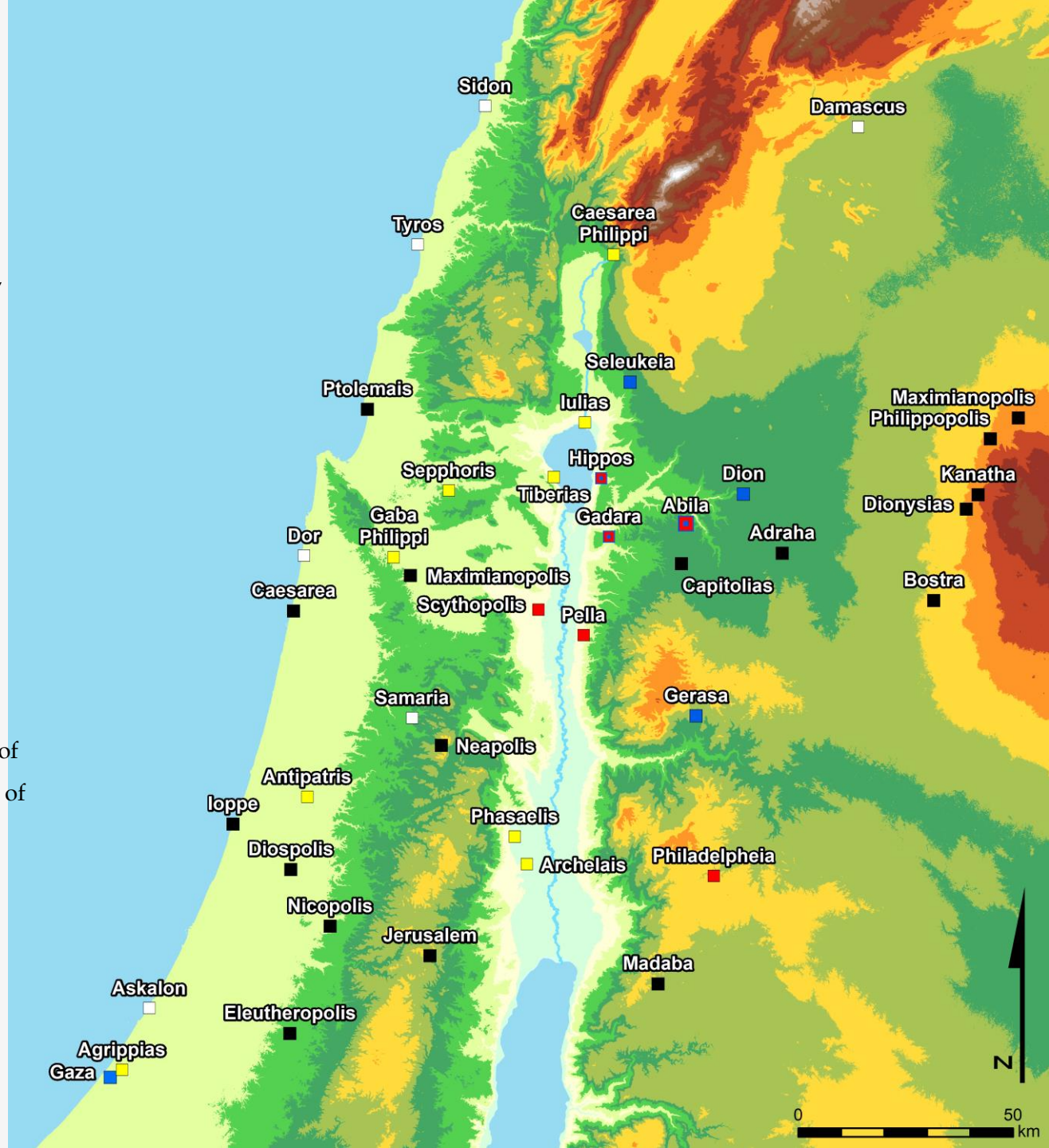

Brief summary

- Entertainment structures in the Hellenistic and Roman Levant were connected with both cult and later on mainly with secular public spectacles
- Herodian construction boom is again unprecedented and has to do with Herod's political intentions
- Early theatres in Scythopolis and Gadara are exceptions
- All such large construction projects reflect a) a need/demand for such structure as a setting for public games (self-representation of a city) and b) ability of a city to build and maintain such structure
- Theatres are most common – versatile structure for most types of games (excluding athletic and horse races)
- Amphitheatres are found predominantly in places with strong Roman presence (legions, veterans) and so they can be taken as weak proxy for Romanization of the Eastern provinces, as they did not spread far beyond the two contexts mentioned above (legionary bases and seats of government; further they are found only in Scythopolis and Gerasa)

- Apart from the Herodian phase we can distinguish three main phases:
 - Late 1st/early 2nd c. CE (Late Flavian-Hadrian)
 - Mid-2nd c. CE (Antonine)
 - Late 2nd/early 3rd c. CE (Severan)